

SALC

An Orbital Arrangement Game

By
Zachary Thammavongsy, PhD
& Madalyn Radlauer, PhD

This file is released under the
United States Copyright Office

You have our permission to...

- Print as much as you want for personal use
- Share this file with friends and family

You may not...

- Mass produce this game for events
- Sell this pdf file or the art within this file
- Modify any of the art within this file

Instructions: Print all pages double sided (the pages are laid out for you to print in one go). After printing, cut the cards along the dash lines. Use a paper trimmer and cut directly on the dash line. We recommend using glossy white paper between 150 gsm and 300 gsm.

Instructions: Print all pages double sided (the pages are layed out for you to print in one go). After printing, cut the cards along the dash lines. Use a paper trimmer and cut directly on the dash line. We reccommend using glossy white paper between 150 gsm and 300 gsm.

**d-ORBITAL
GAMES**

Copyright 2021 d-ORBITAL GAMES, LLC

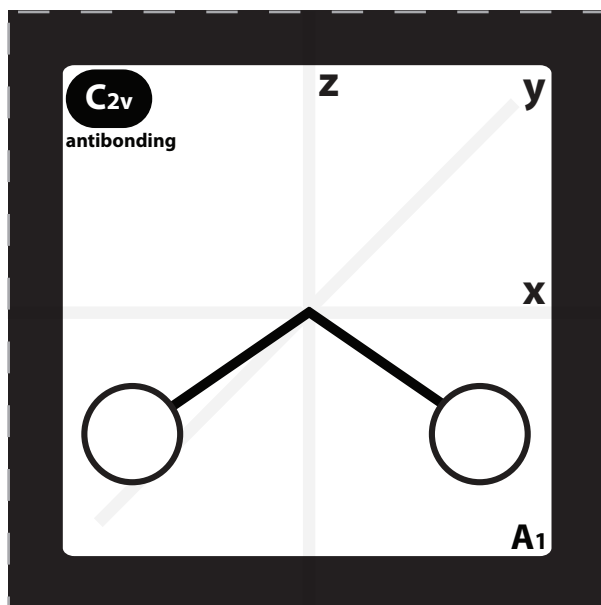
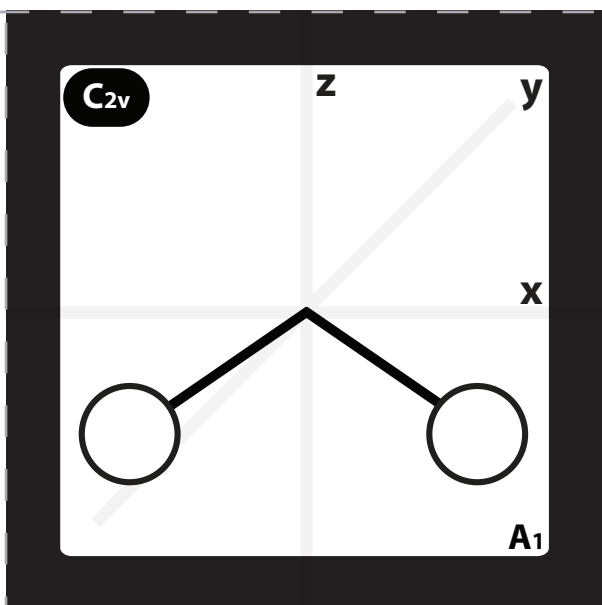
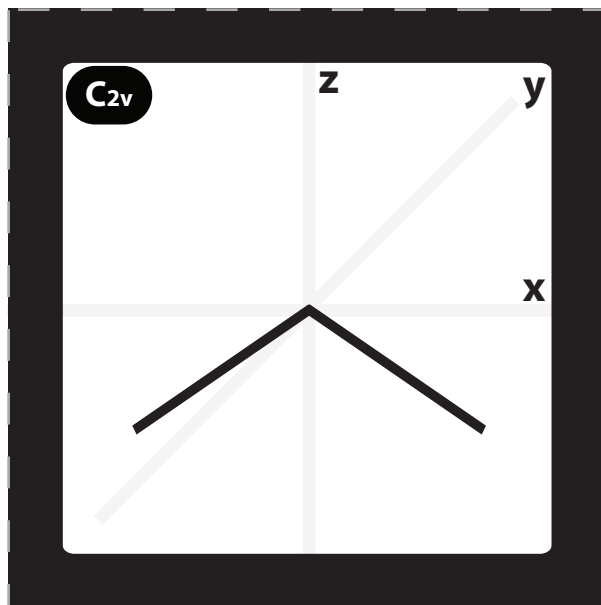
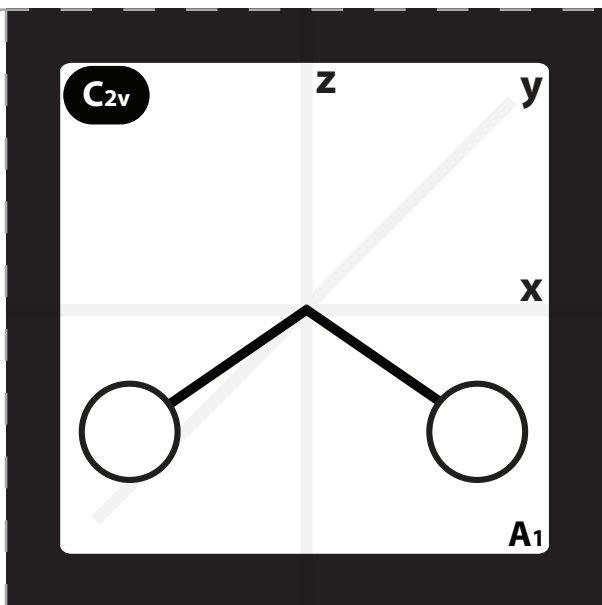
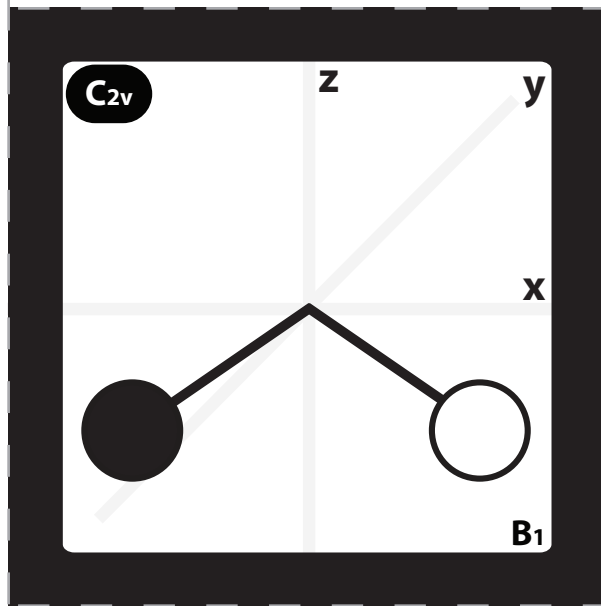
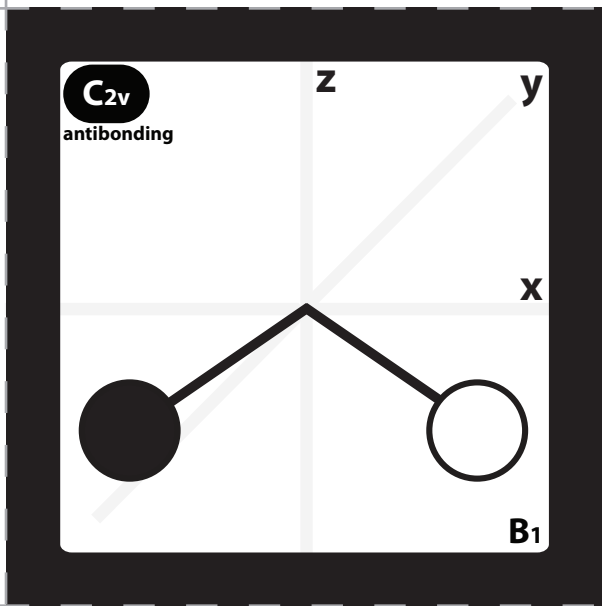

C_{2v}
place up
to 2 LOs

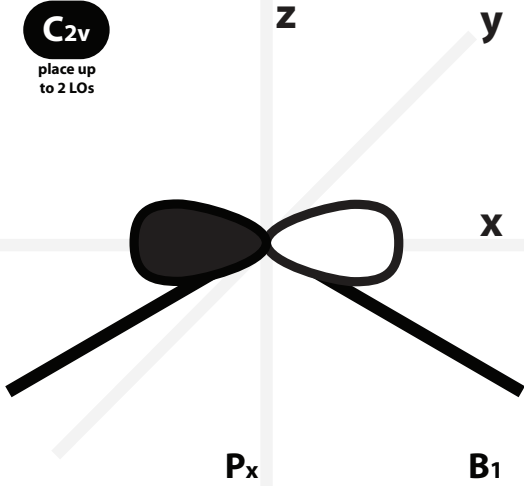

antibonding
C_{2v}
place up
to 2 LOs

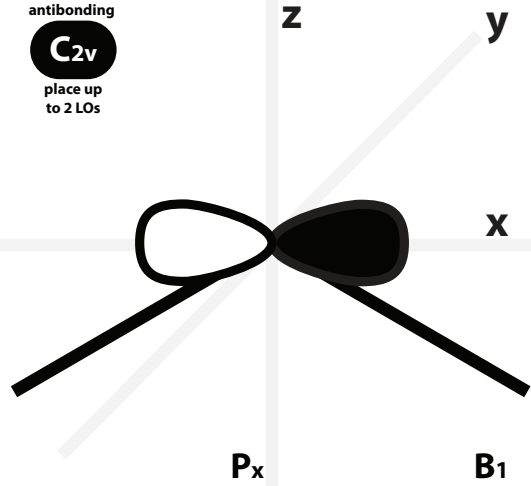

C_{2v}
place up
to 2 LOs

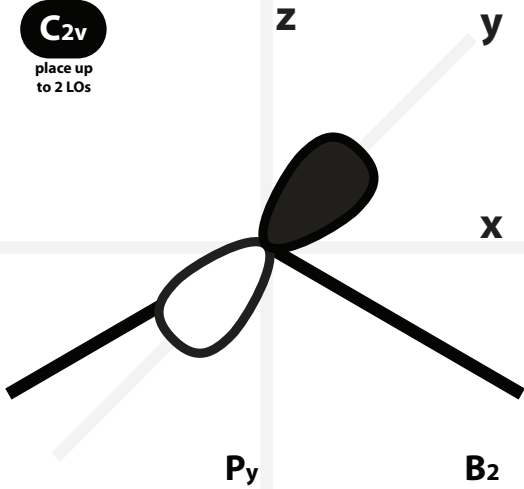

C_{2v}
place up
to 2 LOs

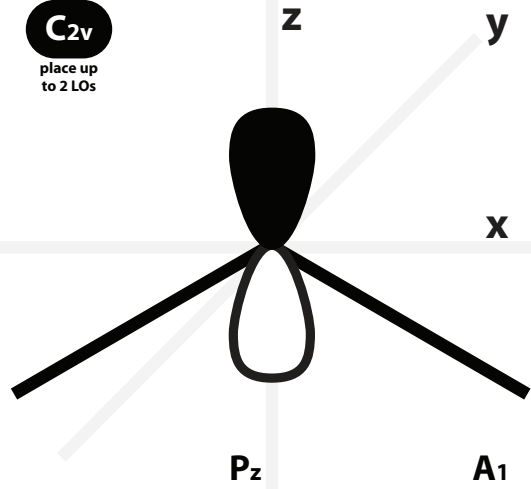

antibonding
C_{2v}
place up
to 2 LOs

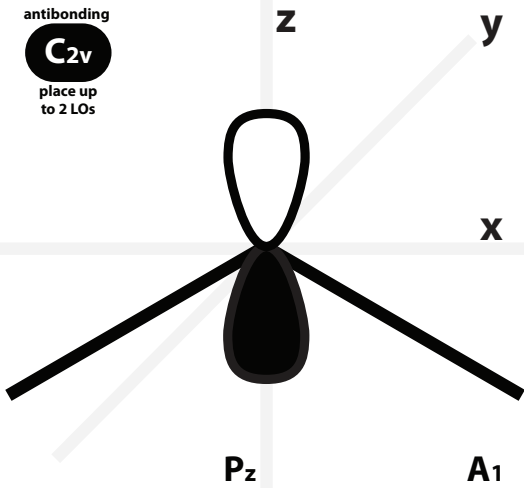

C_{2v}
place up
to 2 LOs

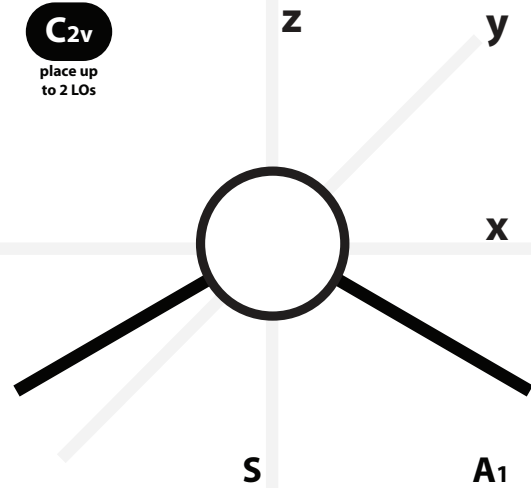

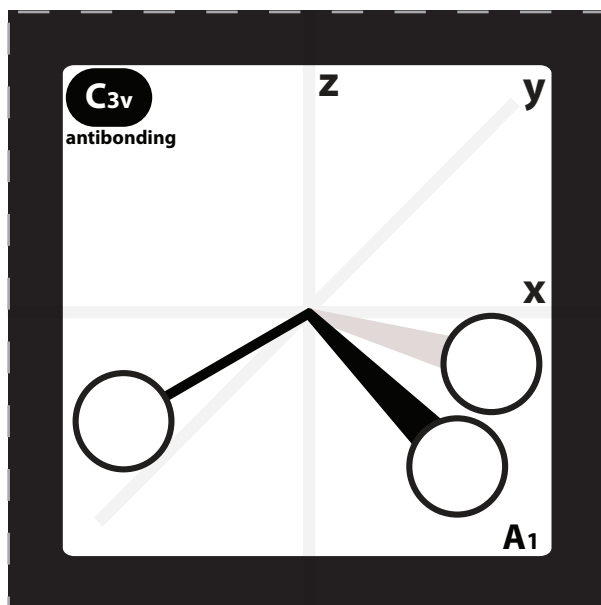
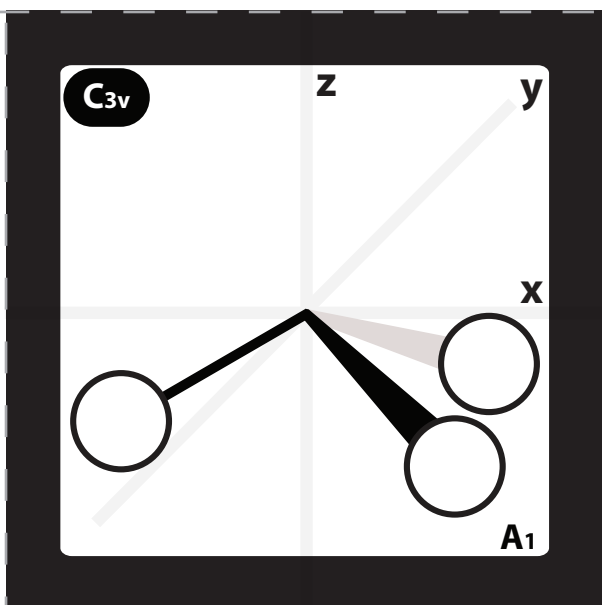
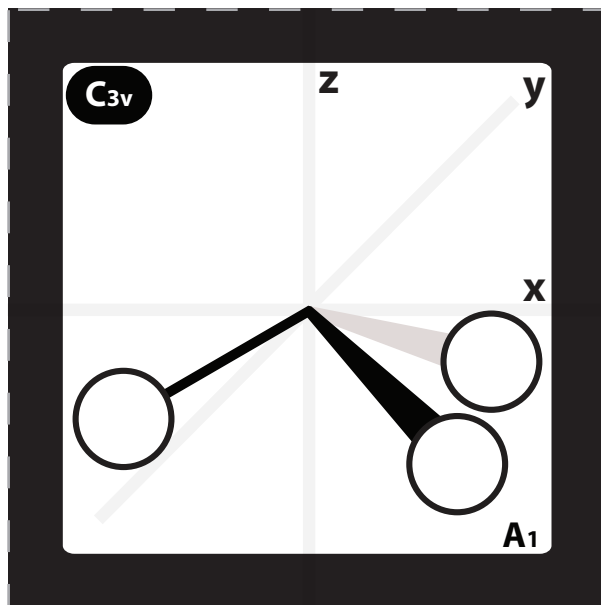
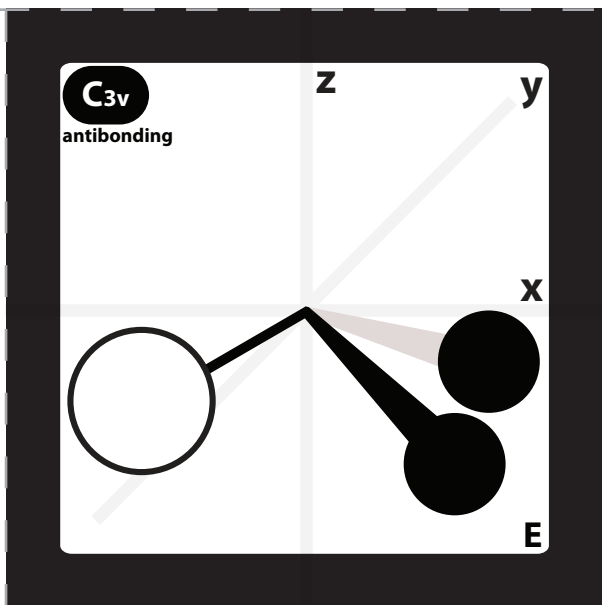
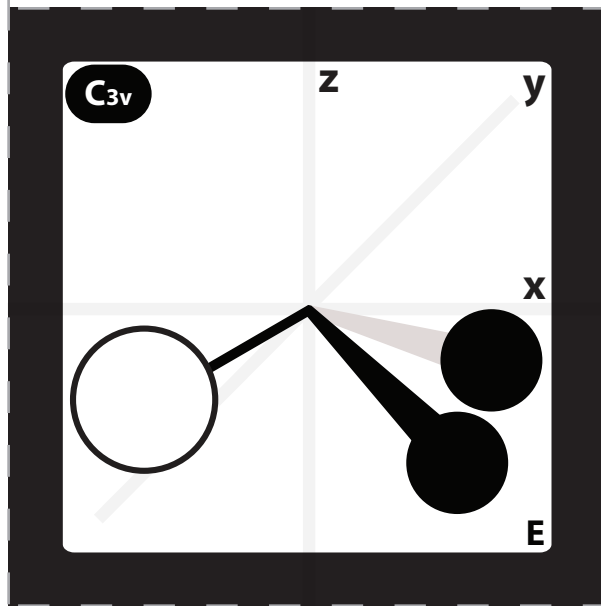
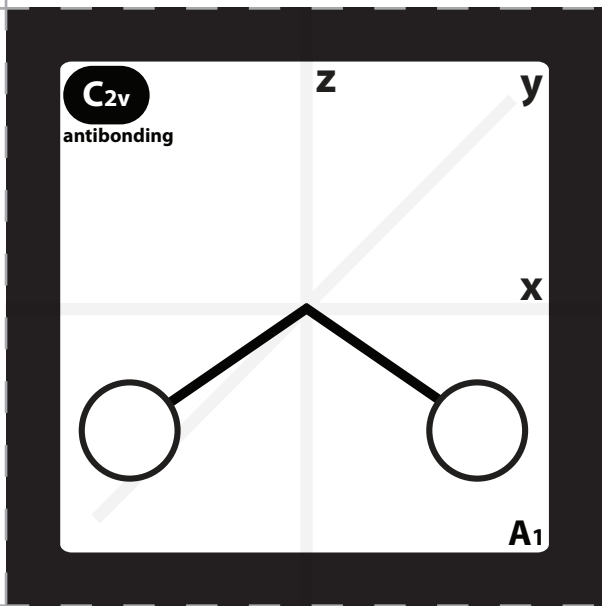

C_{3v}
place up
to 3 LOs

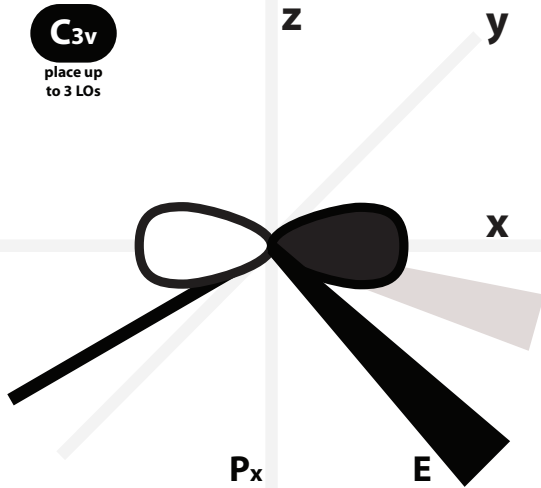

antibonding
C_{2v}
place up
to 2 LOs

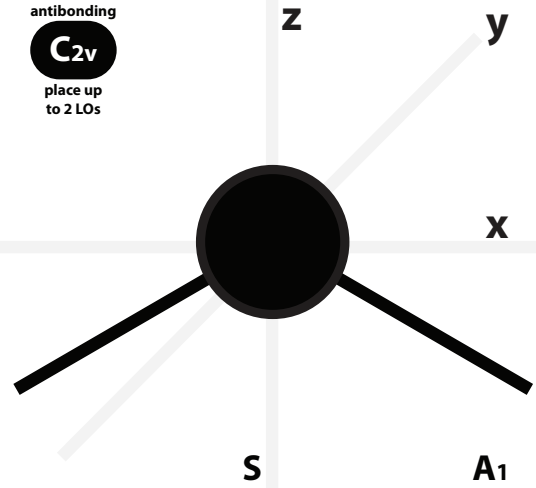

C_{3v}
place up
to 3 LOs

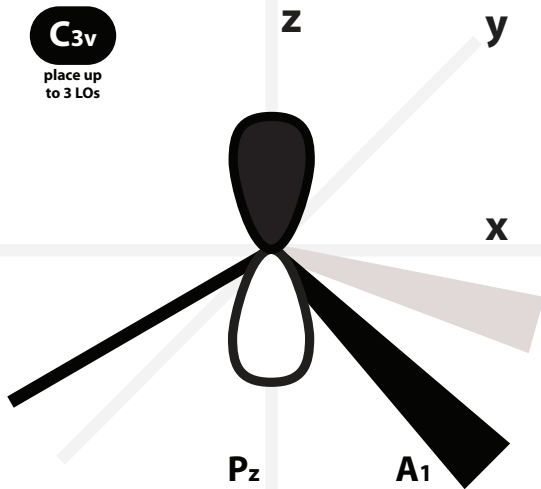

antibonding
C_{3v}
place up
to 3 LOs

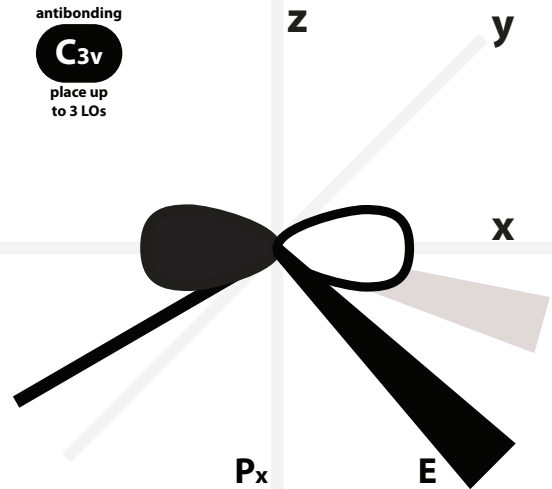

antibonding
C_{3v}
place up
to 3 LOs

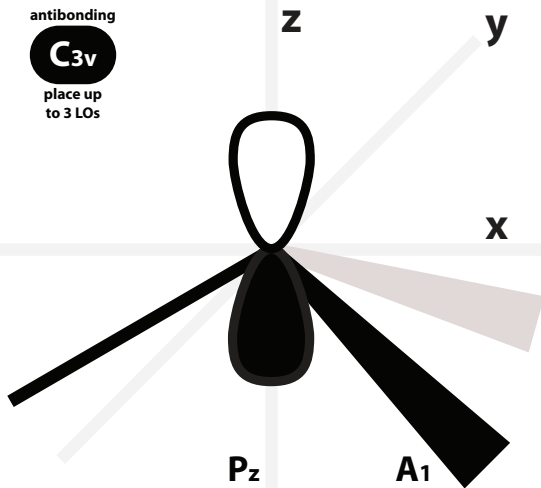

C_{3v}
place up
to 3 LOs

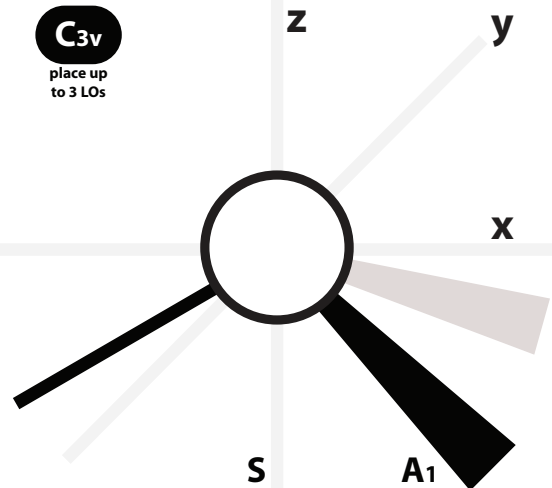

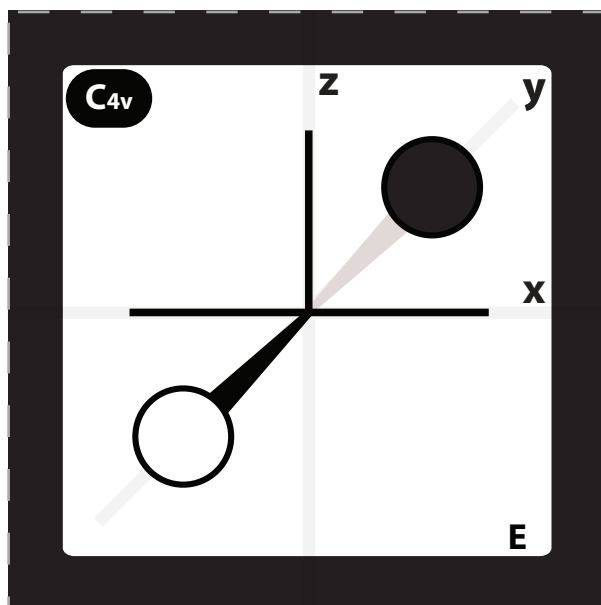
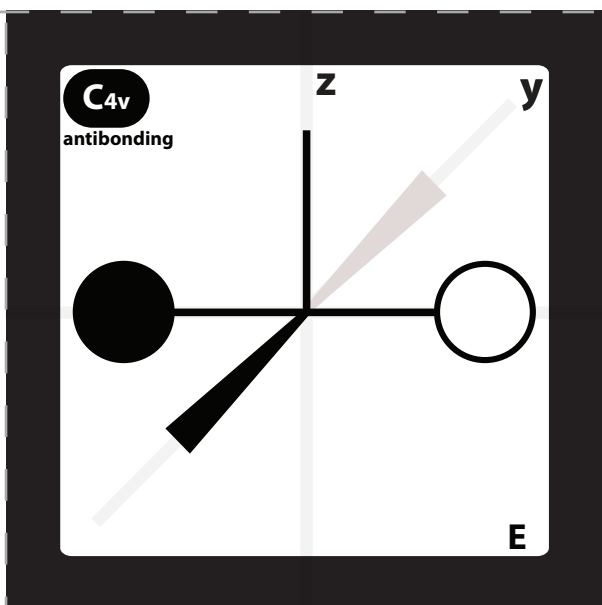
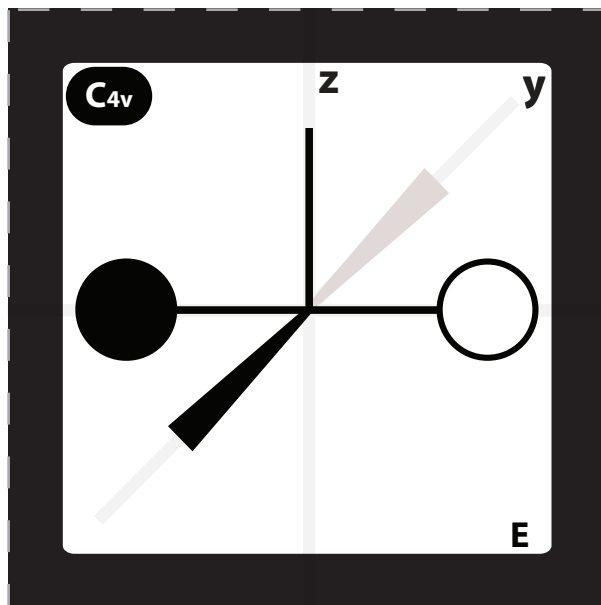
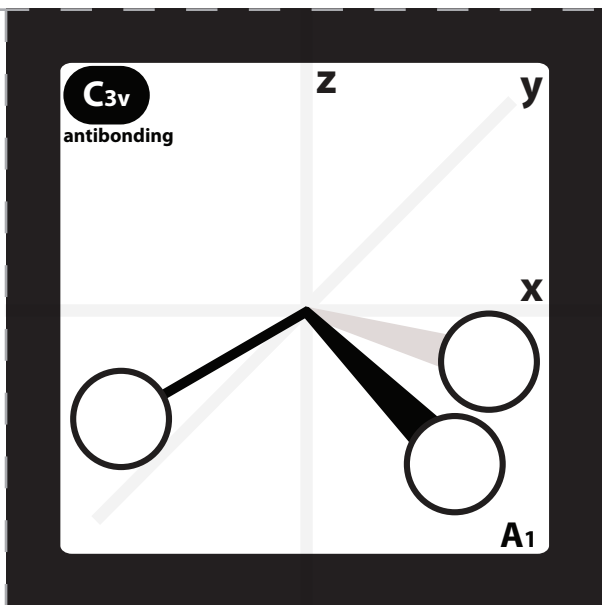
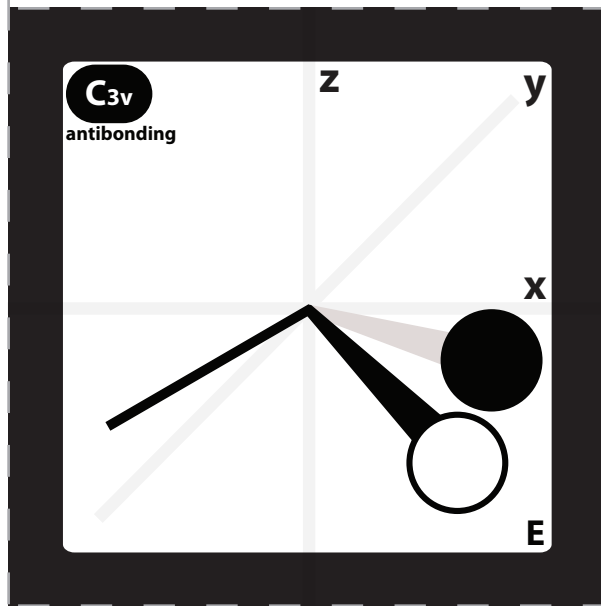
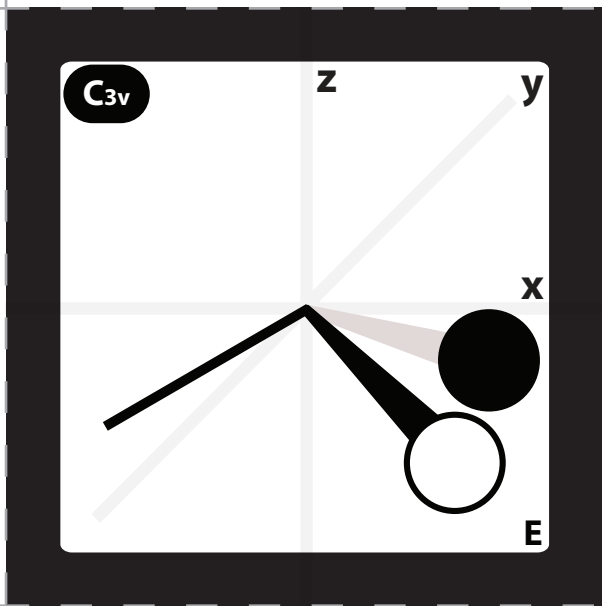

antibonding
C_{3v}
place up
to 3 LOs

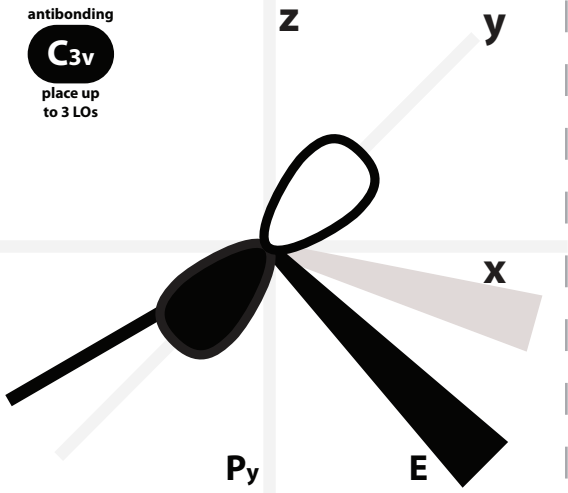

C_{3v}
place up
to 3 LOs

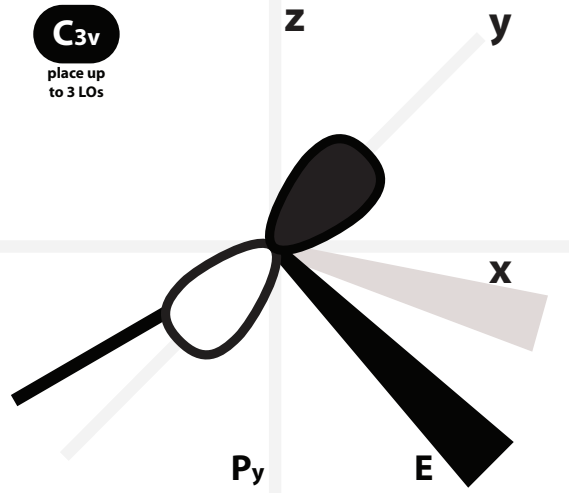

C_{4v}
place up
to 5 LOs

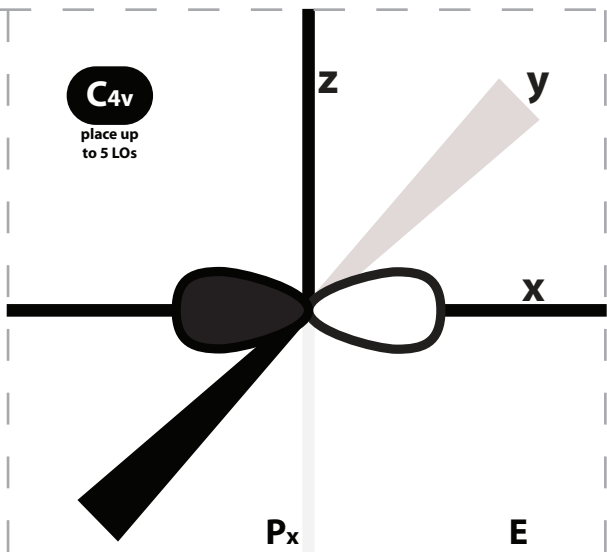

antibonding
C_{3v}
place up
to 3 LOs

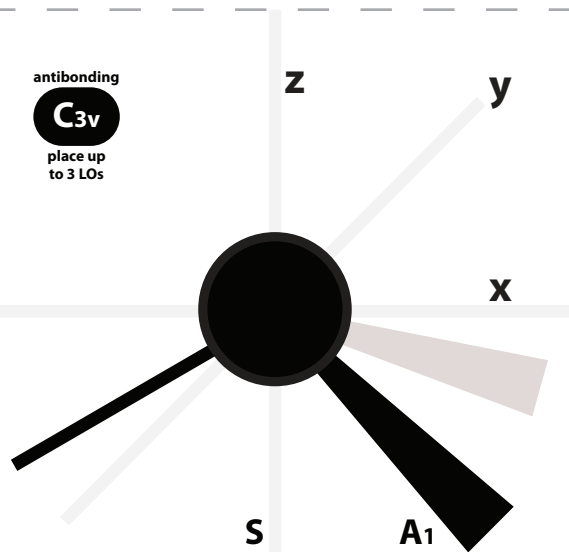

C_{4v}
place up
to 5 LOs

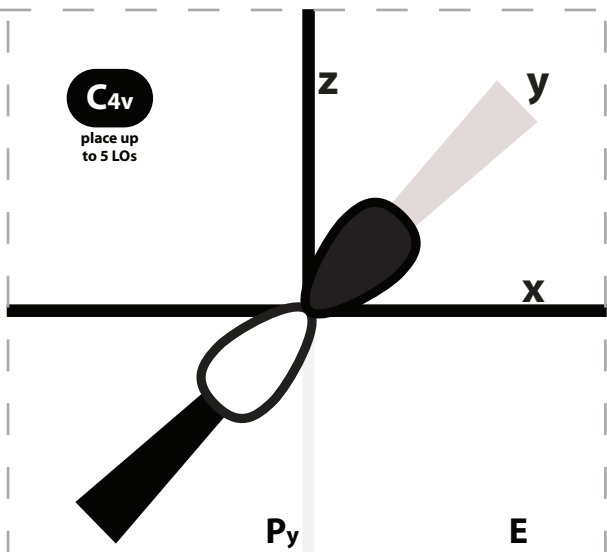

antibonding
C_{4v}
place up
to 5 LOs

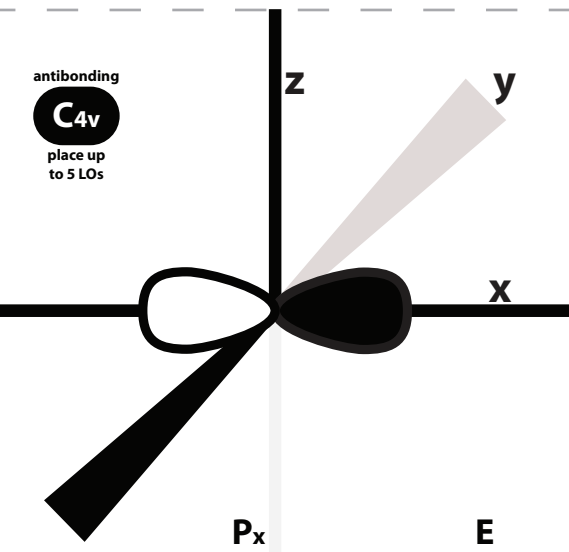

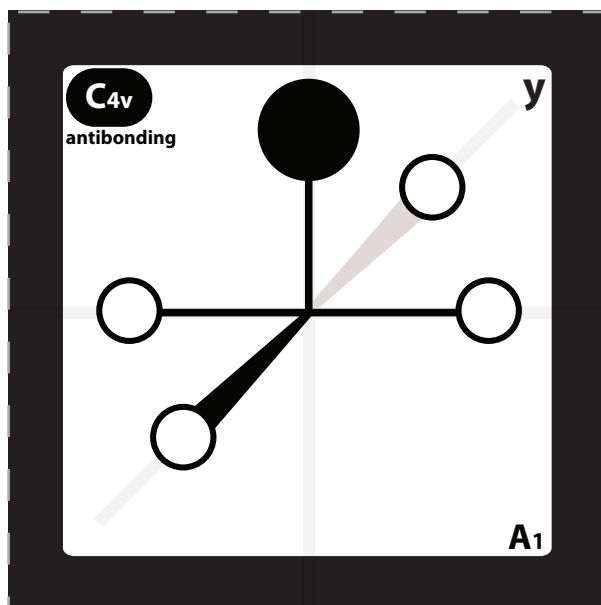
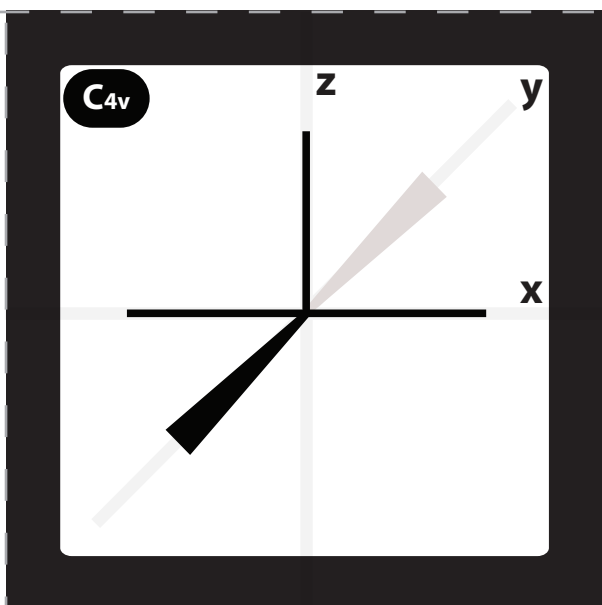
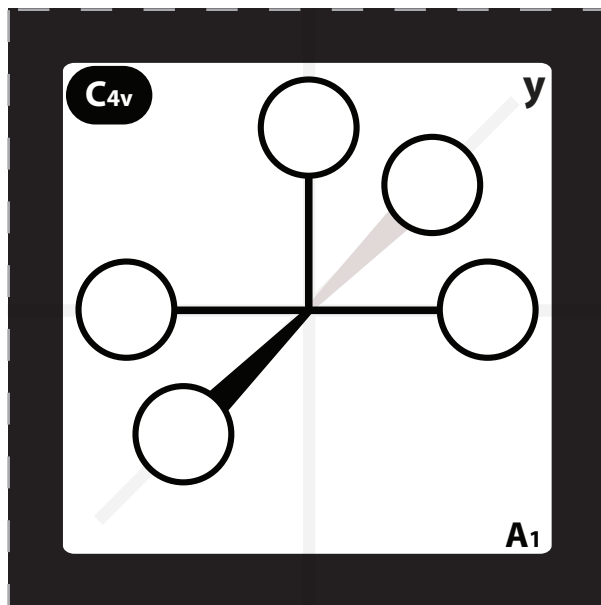
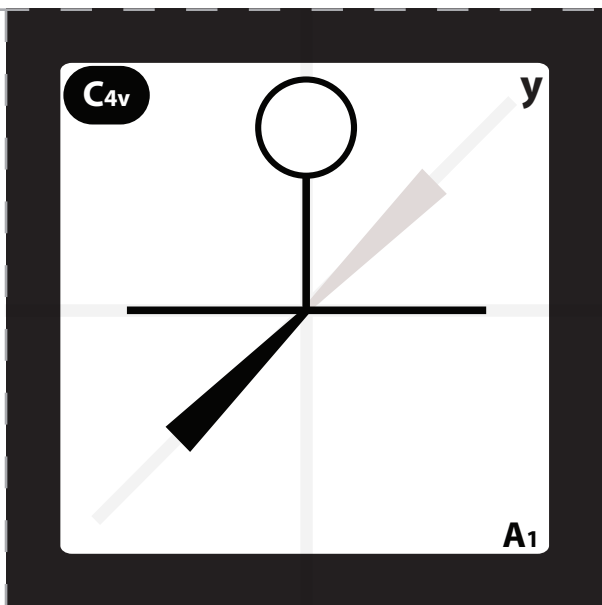
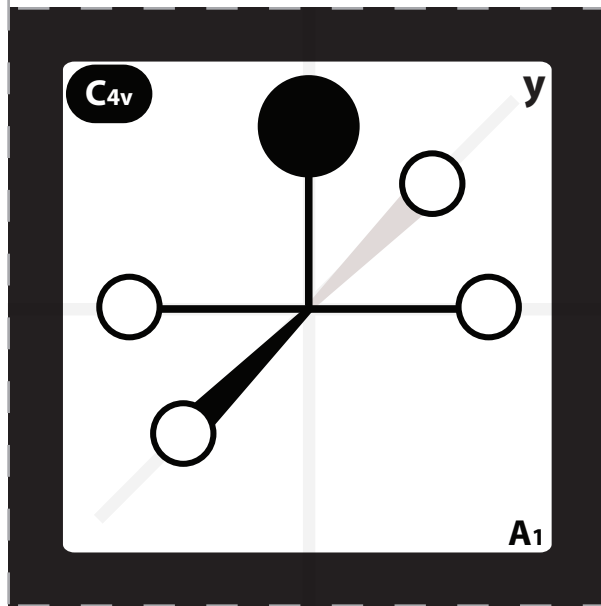
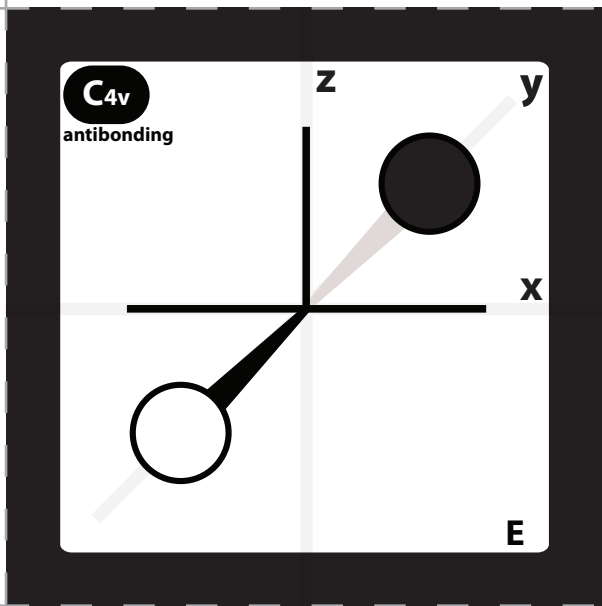

C_{4v}
place up
to 5 LOs

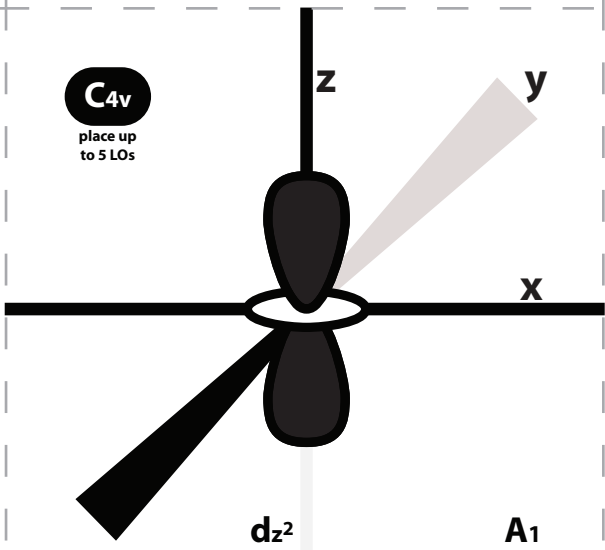

antibonding
C_{4v}
place up
to 5 LOs

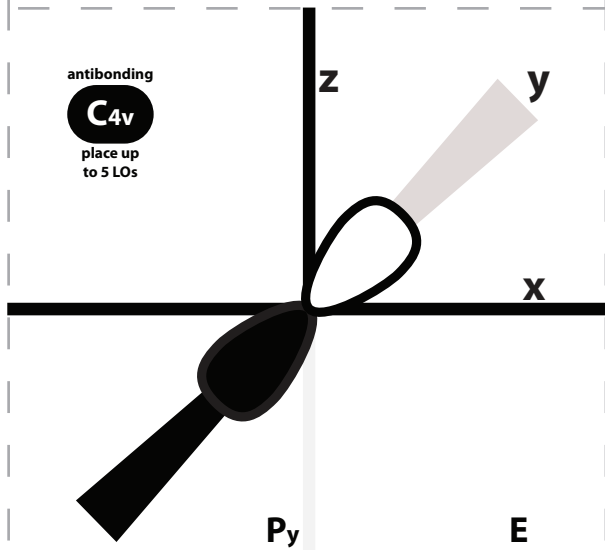

C_{4v}
place up
to 5 LOs

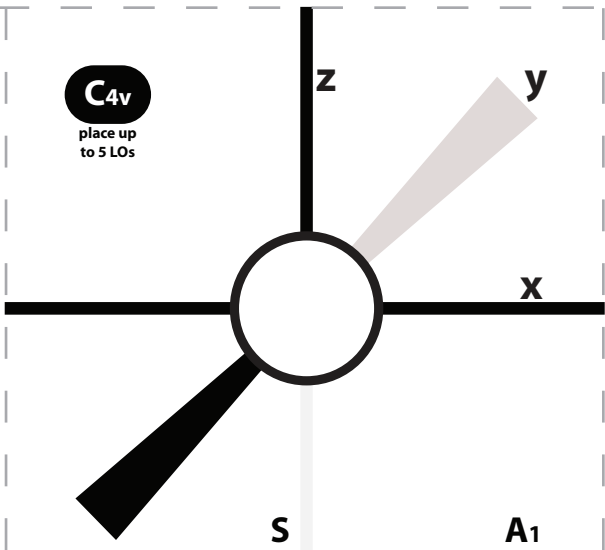

C_{4v}
place up
to 5 LOs

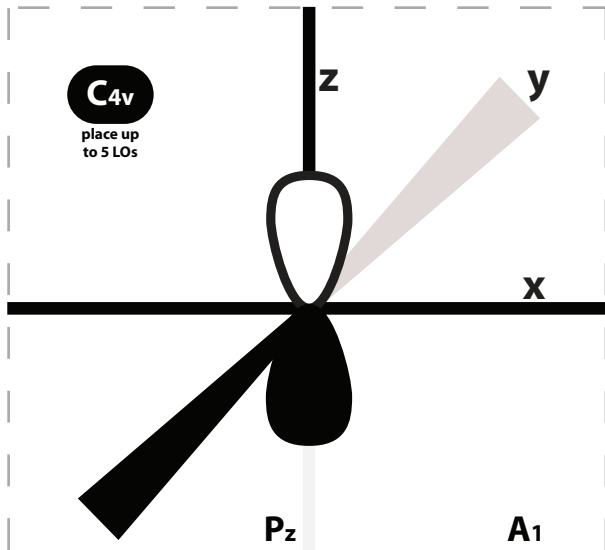

antibonding
C_{4v}
place up
to 5 LOs

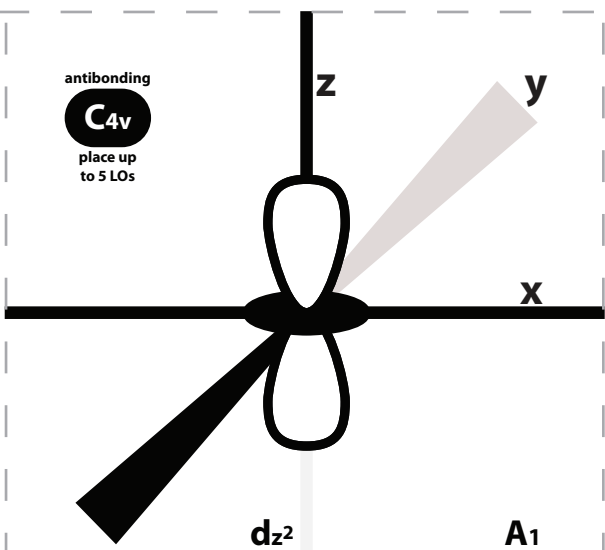

C_{4v}
place up
to 5 LOs

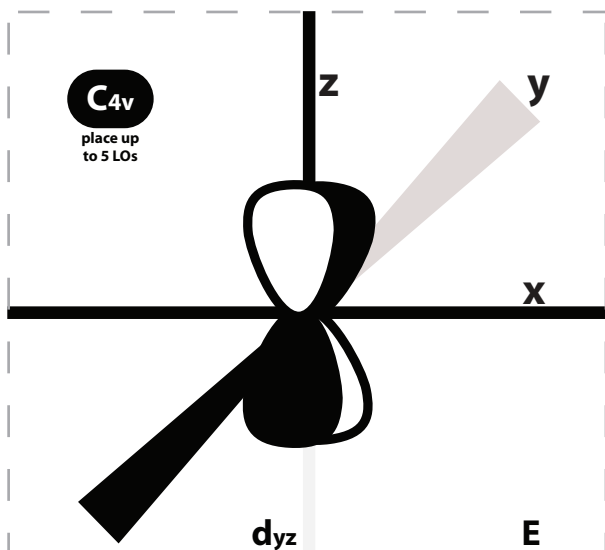

C_{4v}
antibonding

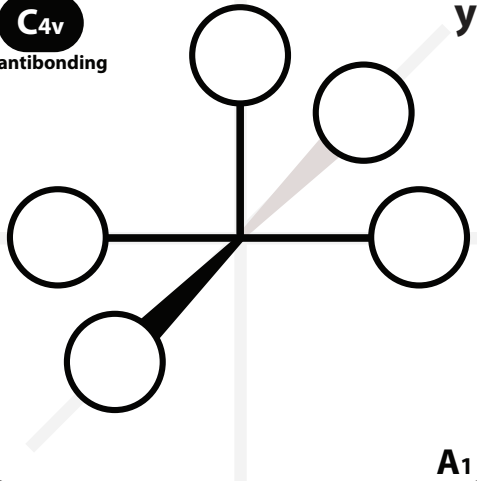

A₁

C_{4v}

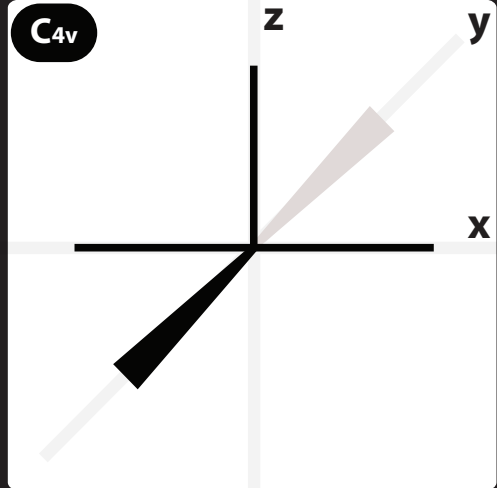

C_{4v}

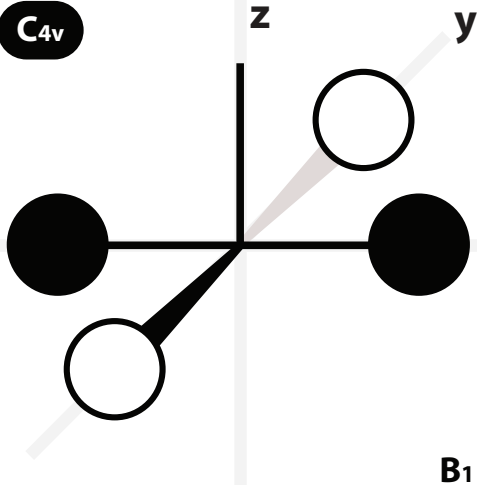

B₁

C_{4v}

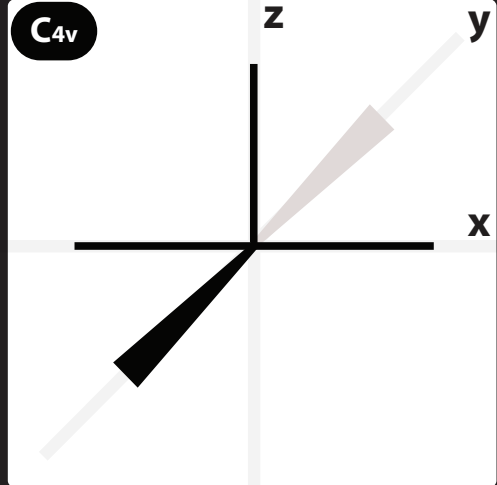

C_{4v}
antibonding

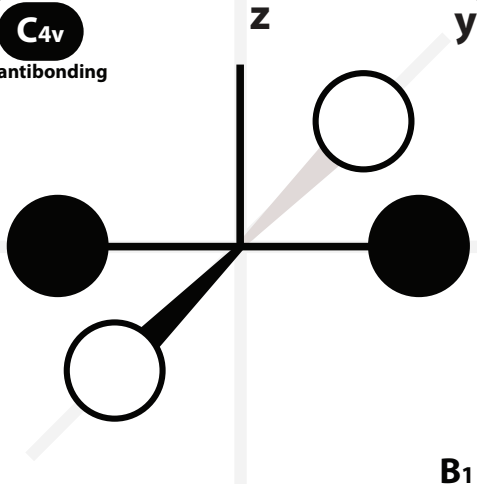

B₁

C_{4v}
antibonding

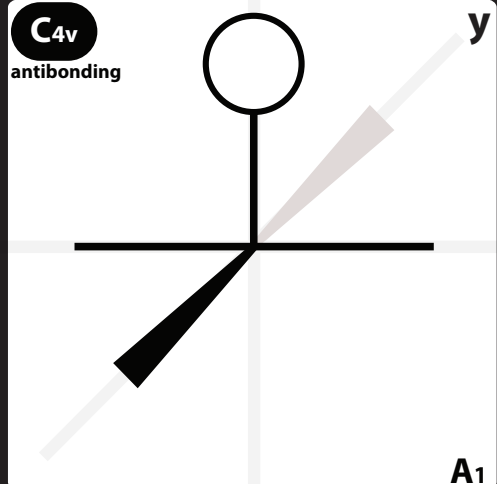

A₁

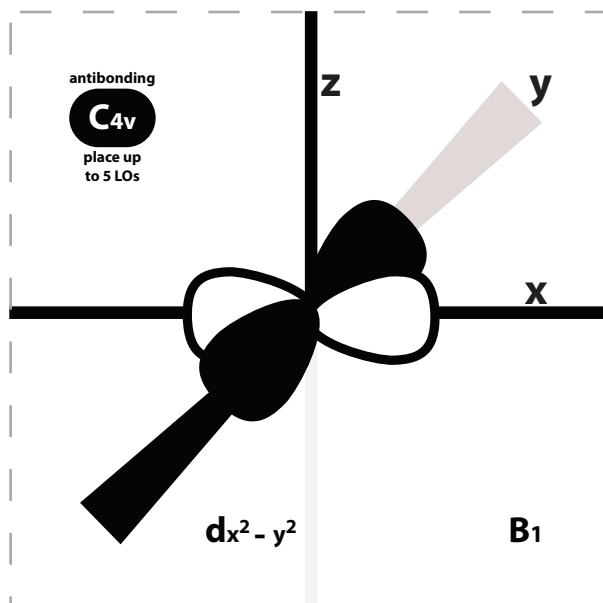
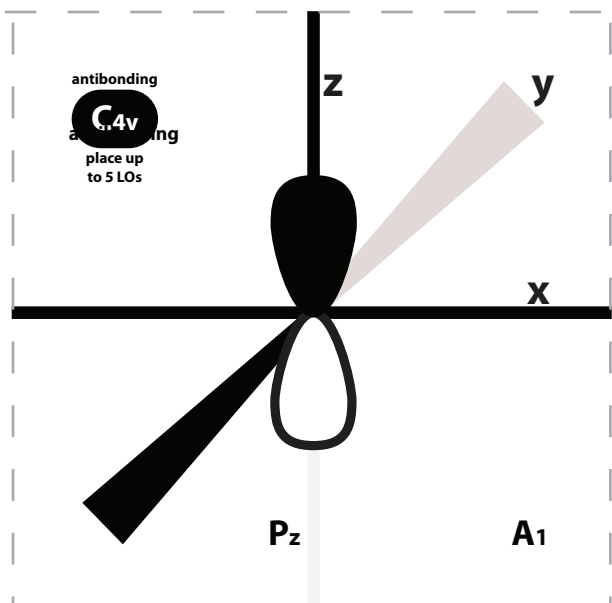
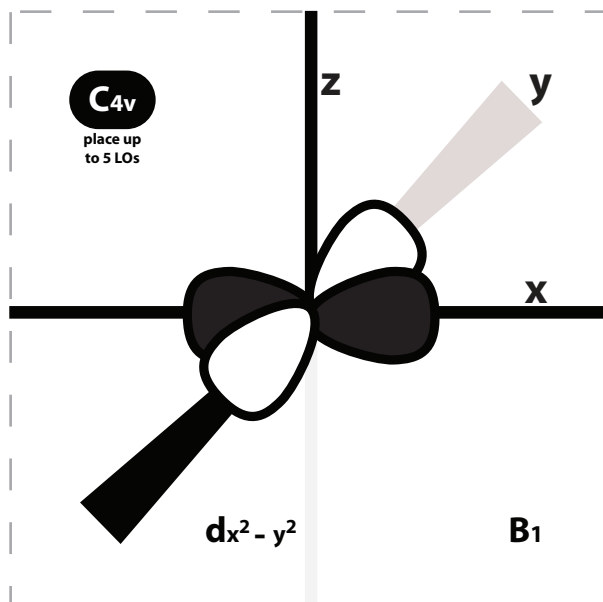
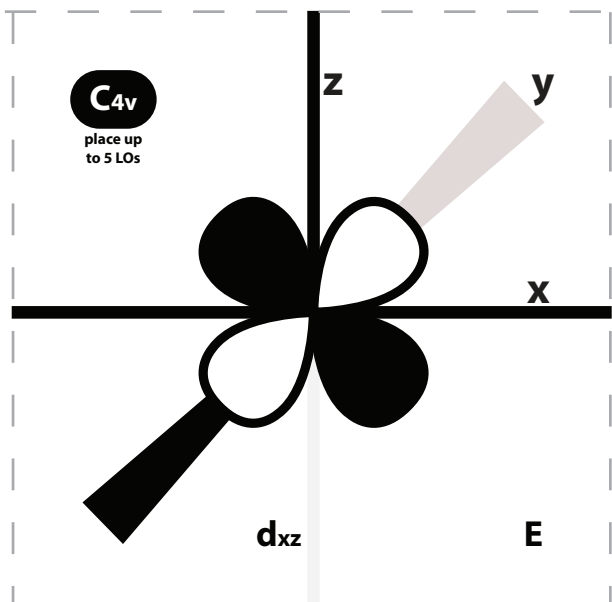
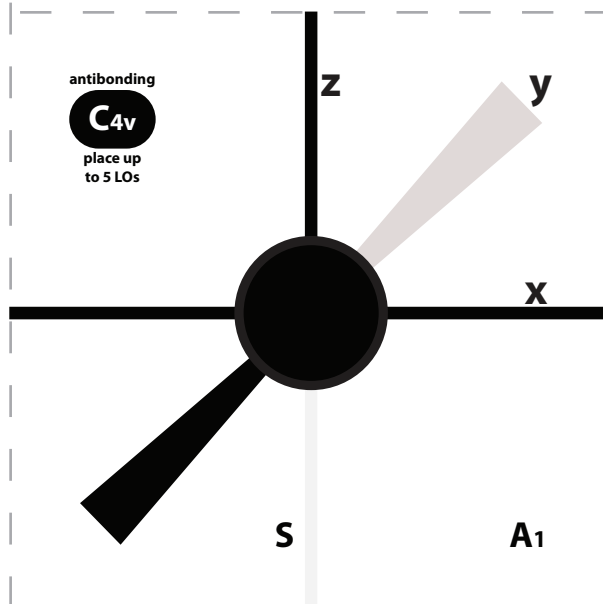
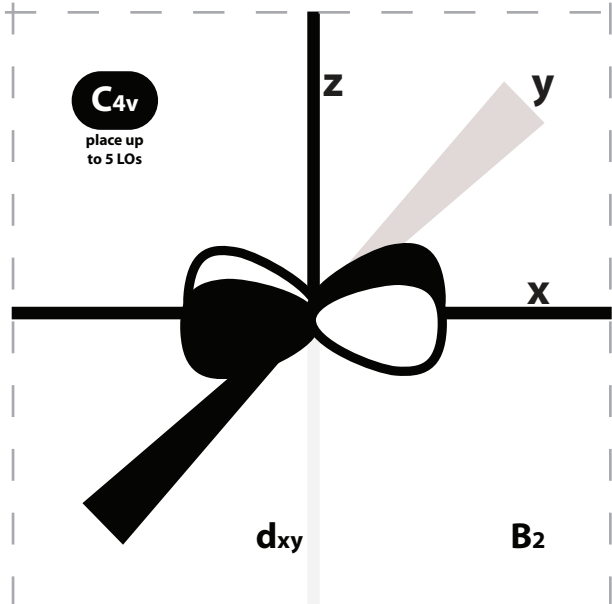

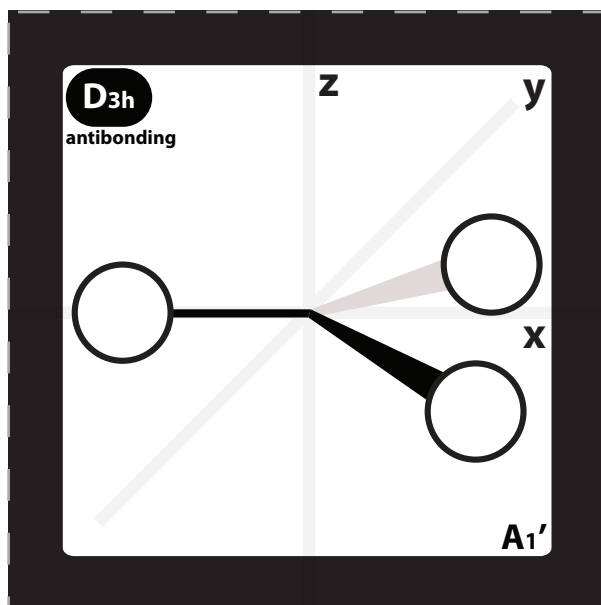
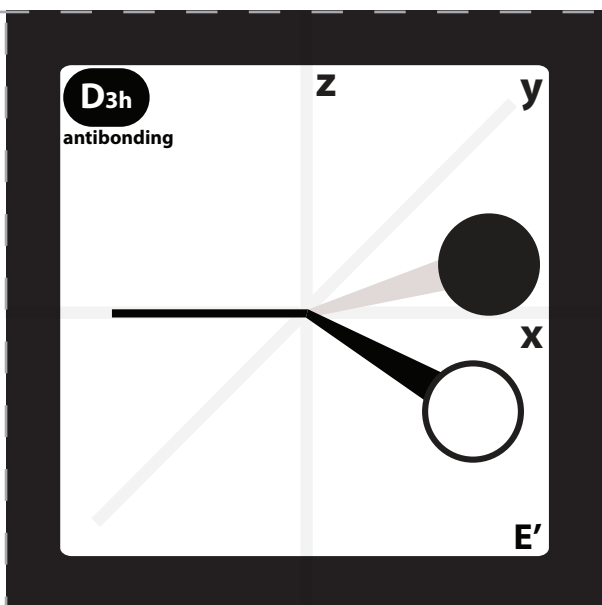
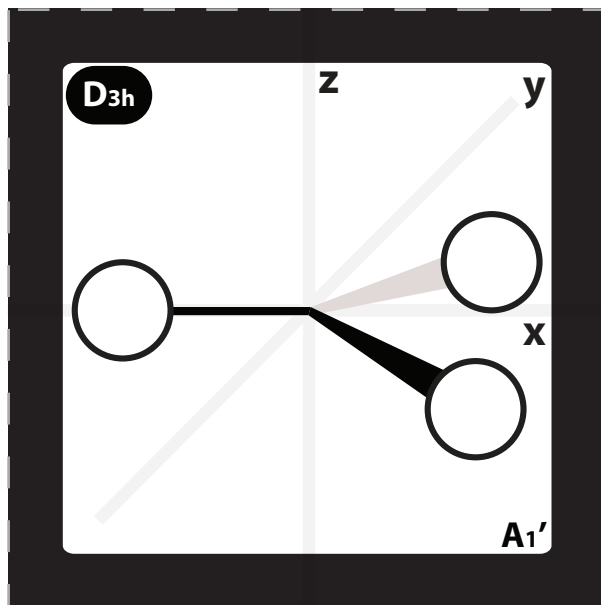
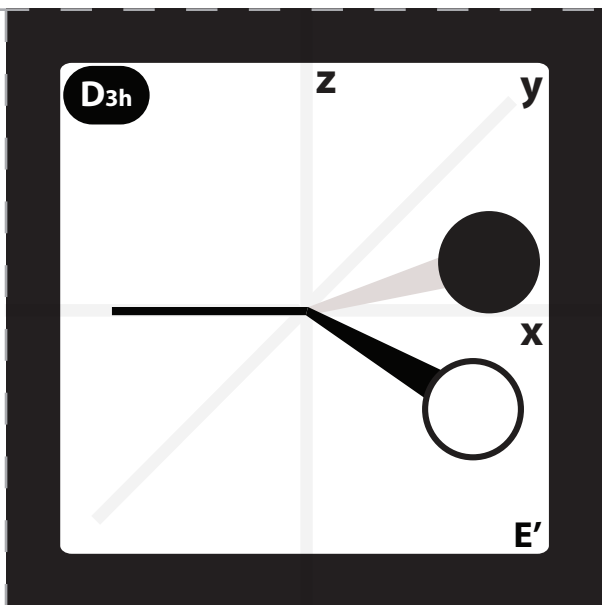
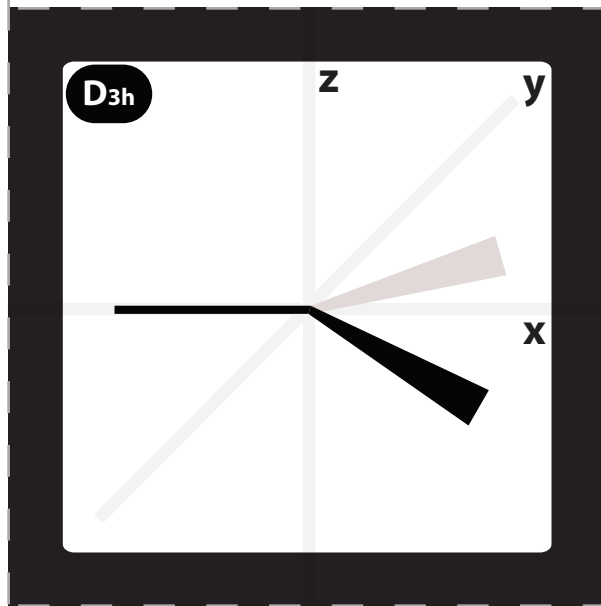
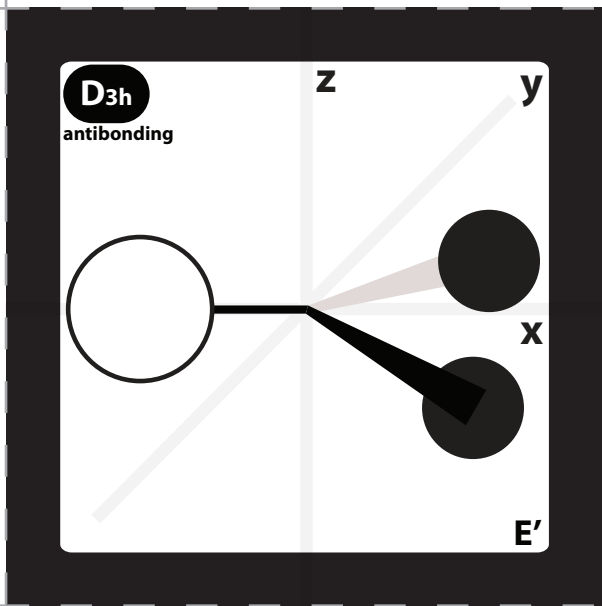

D_{3h}
place up
to 3 LOs

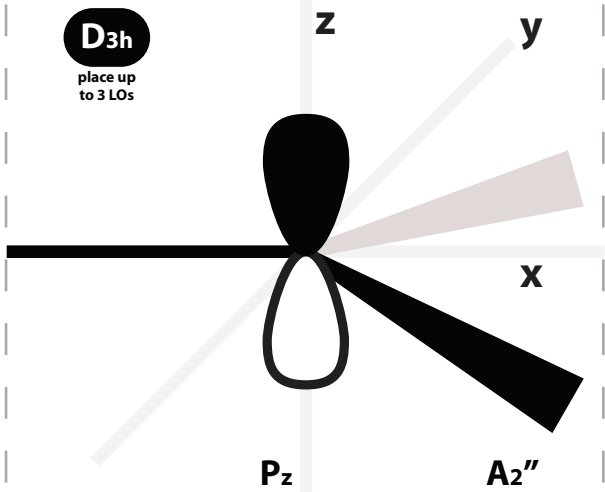

antibonding
D_{3h}
place up
to 3 LOs

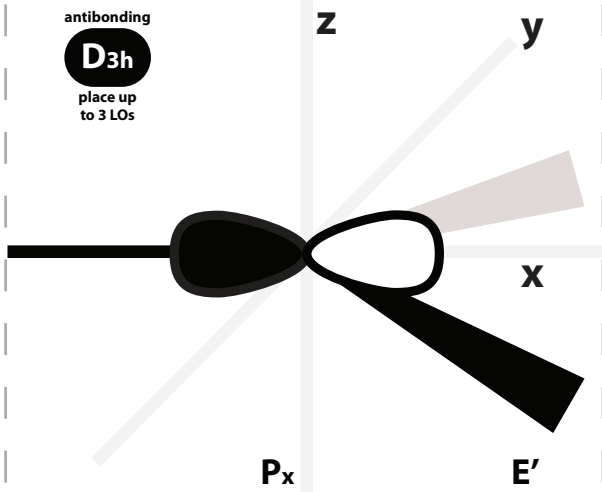

D_{3h}
place up
to 3 LOs

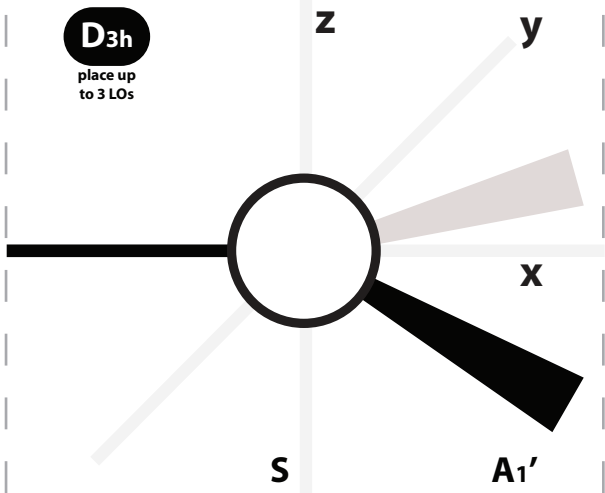

D_{3h}
place up
to 3 LOs

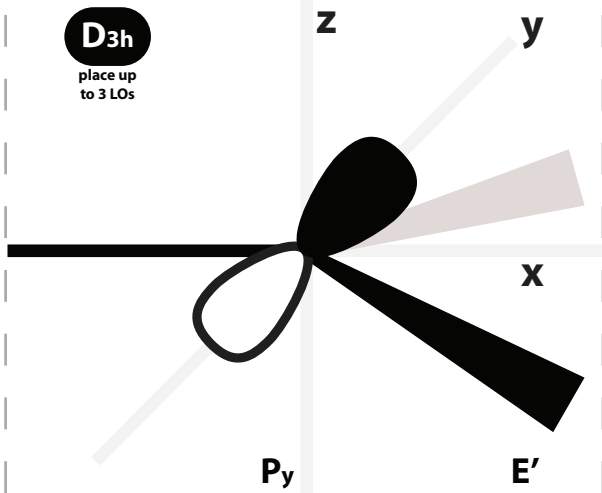

antibonding
D_{3h}
place up
to 3 LOs

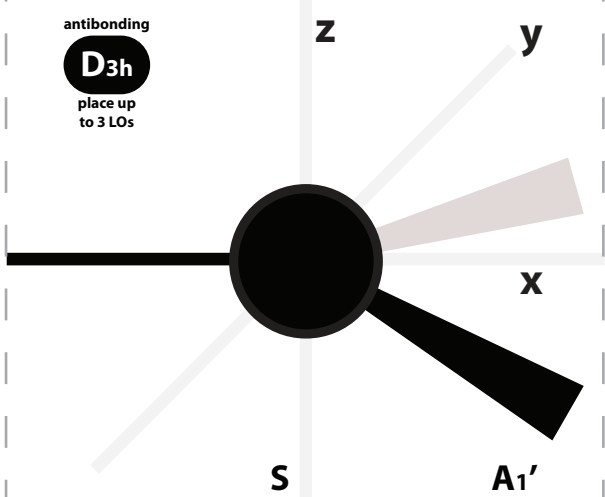

antibonding
D_{3h}
place up
to 3 LOs

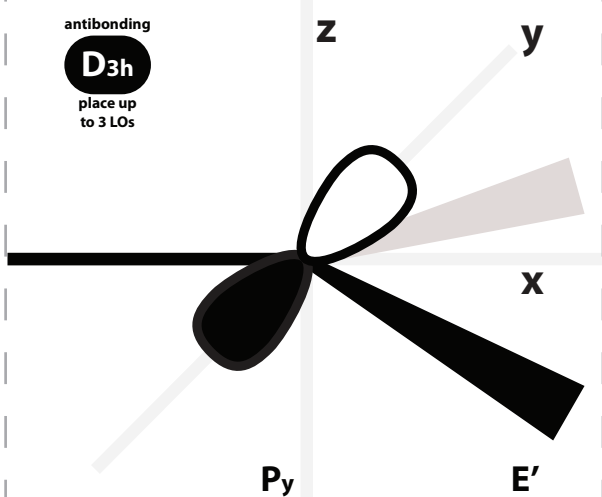

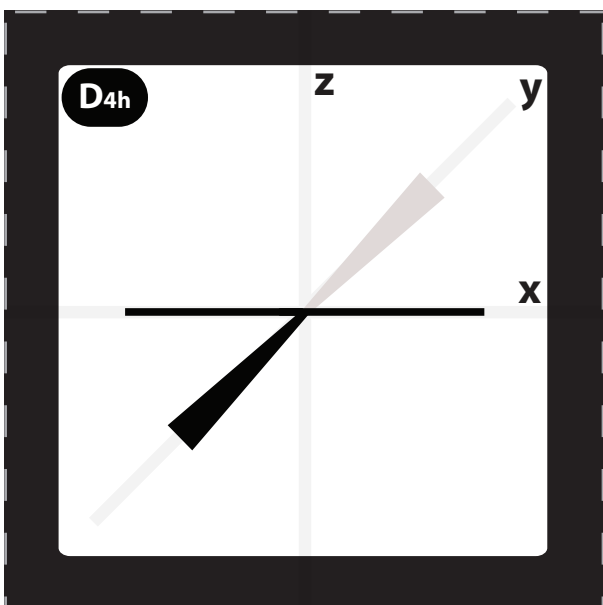
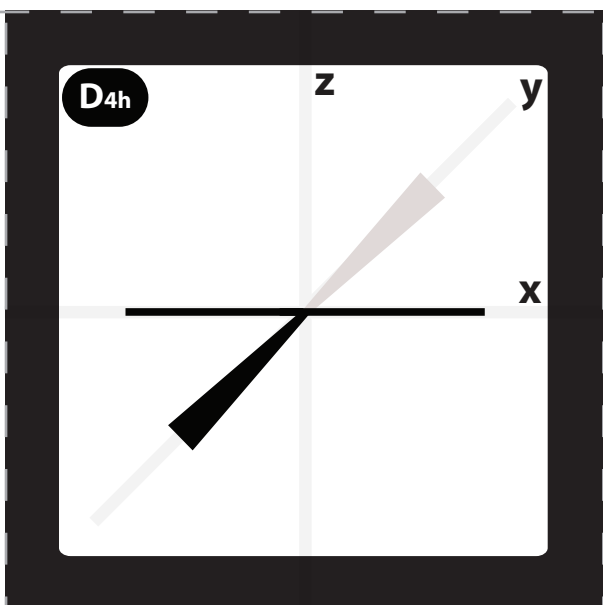
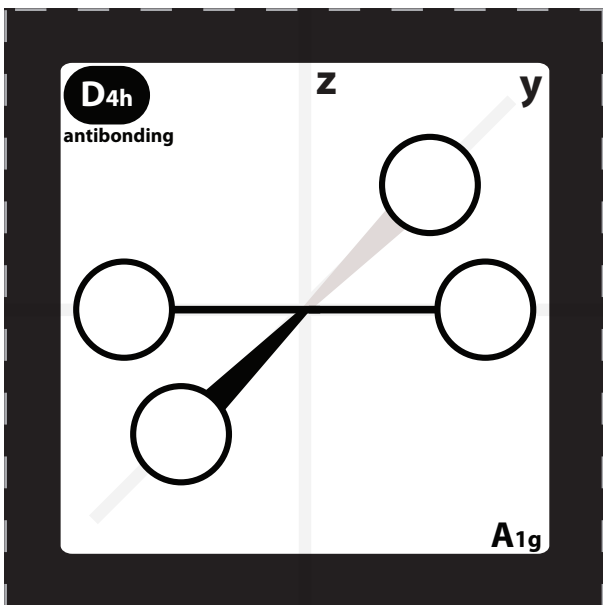
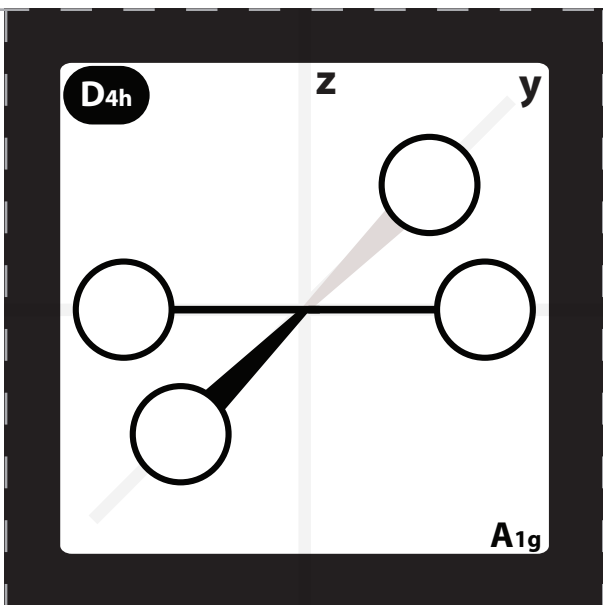
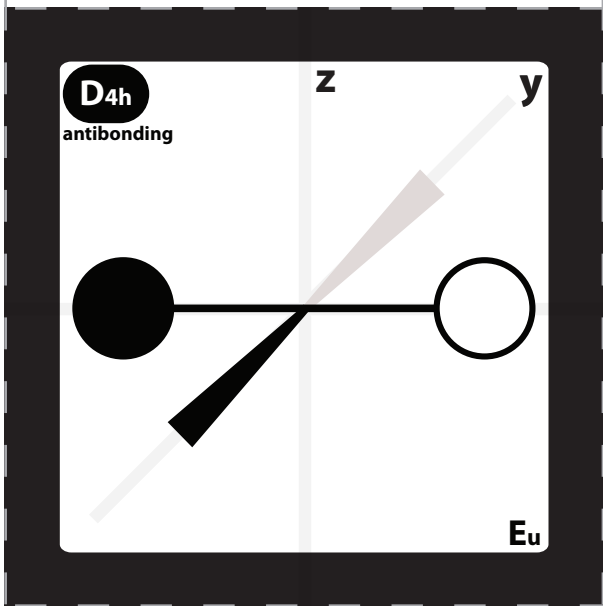
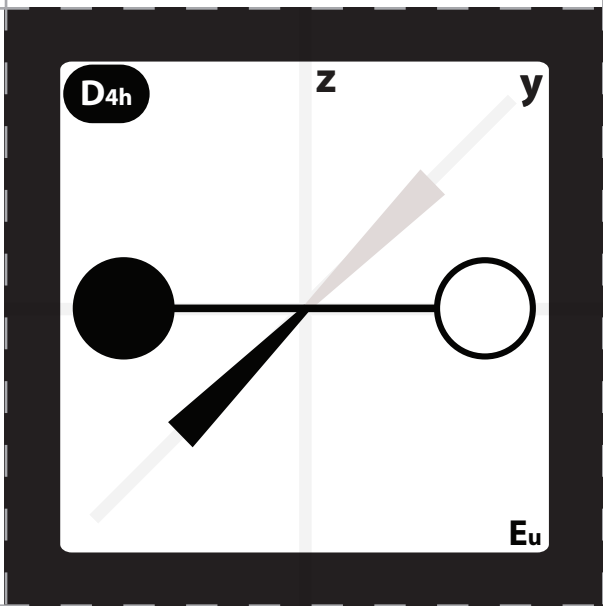

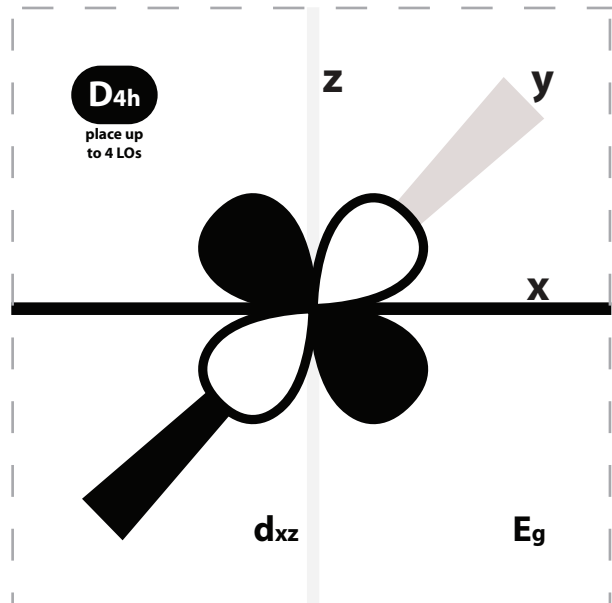
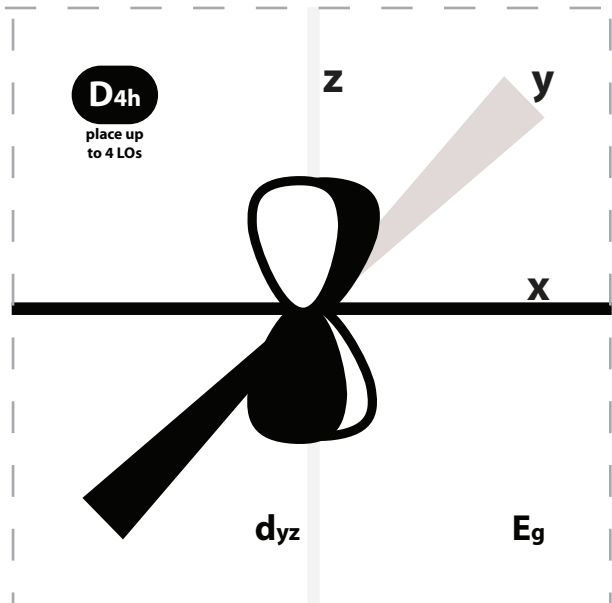
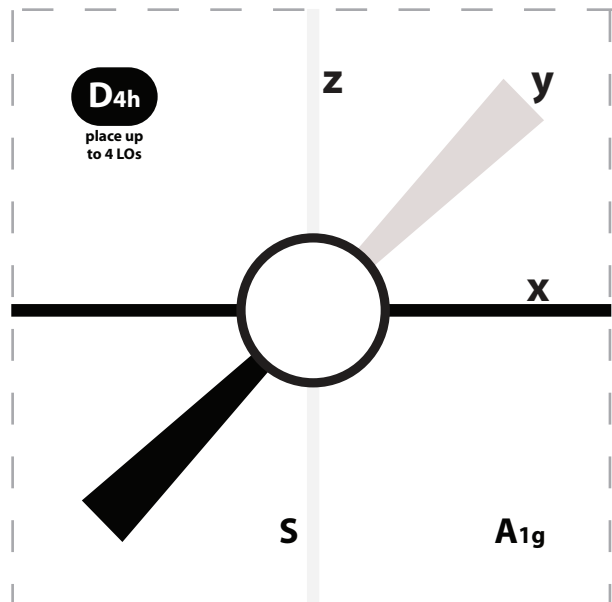
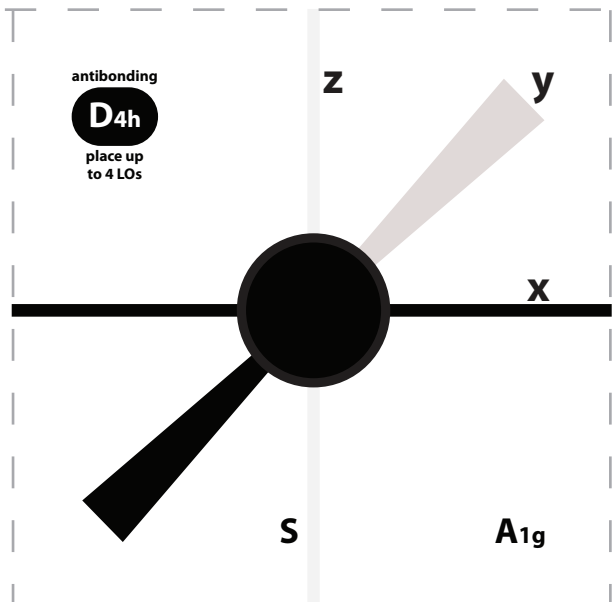
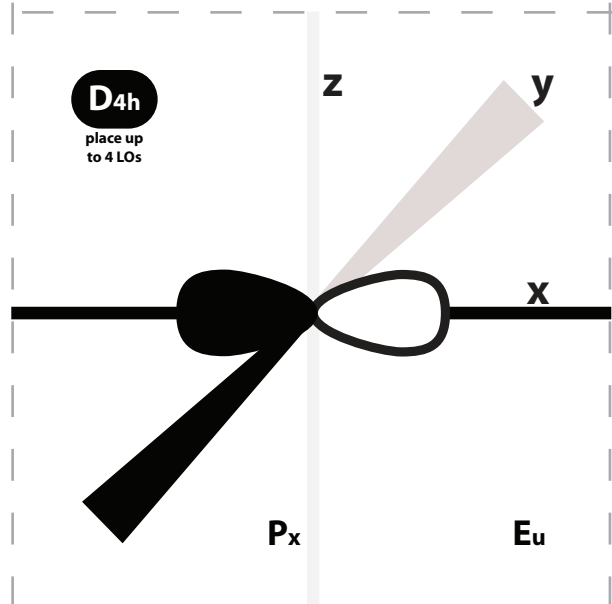
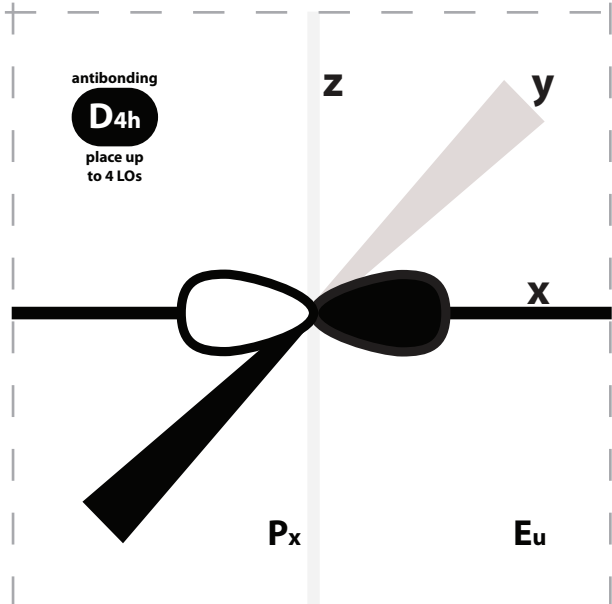

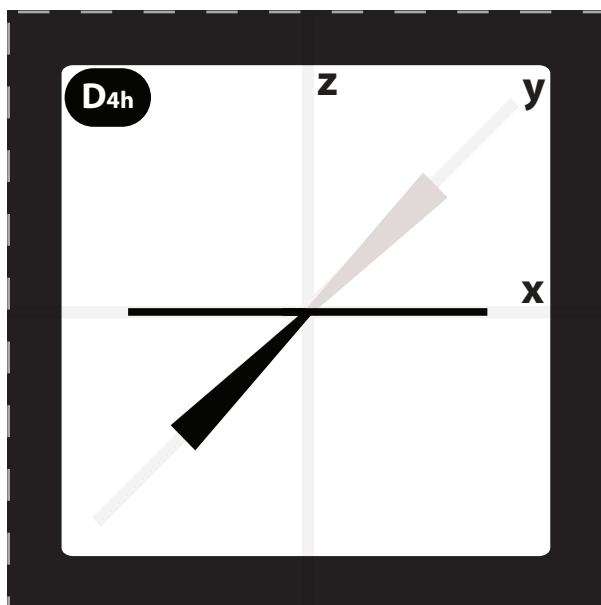
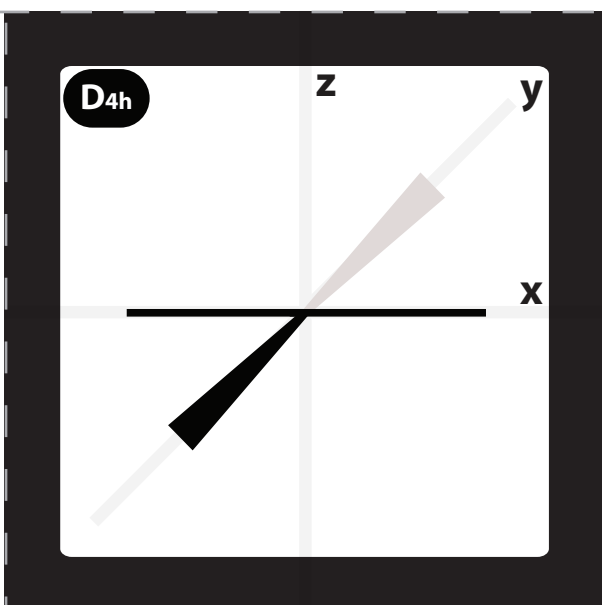
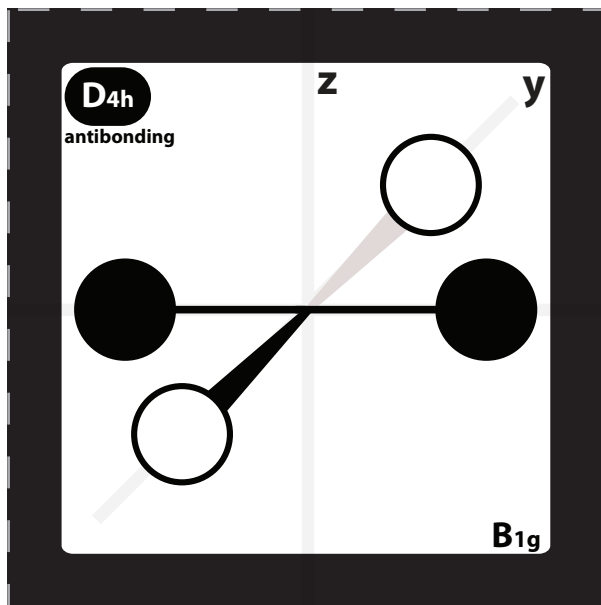
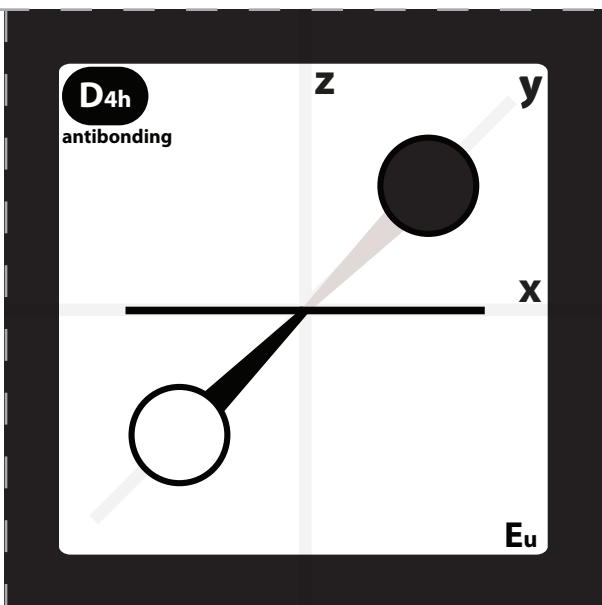
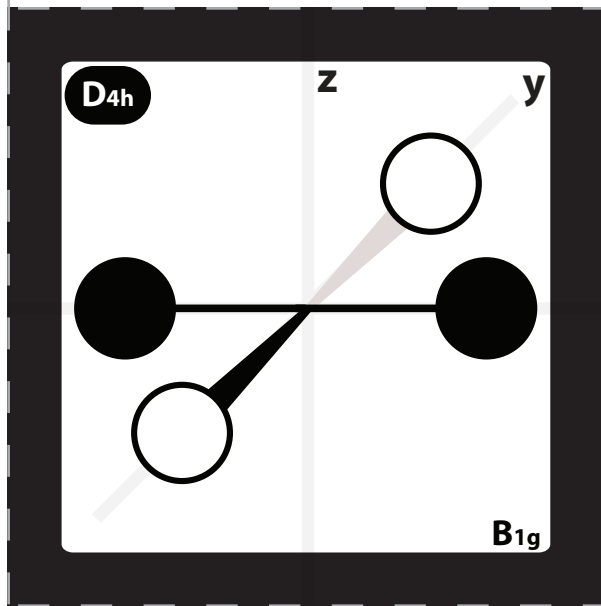
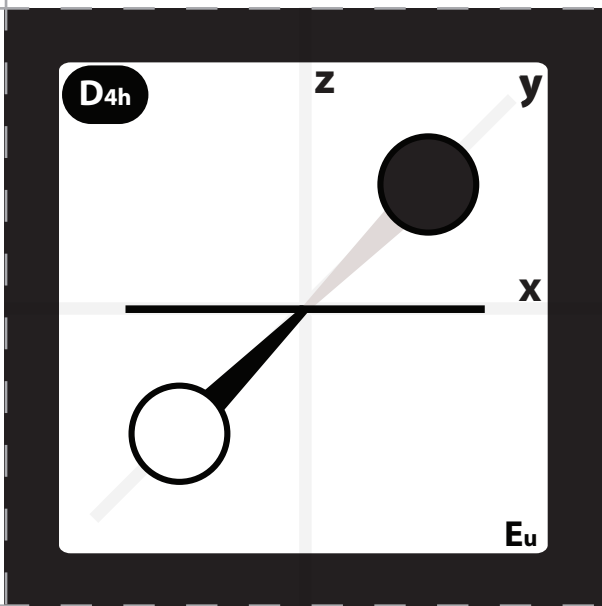

D_{4h}
place up
to 4 LOs

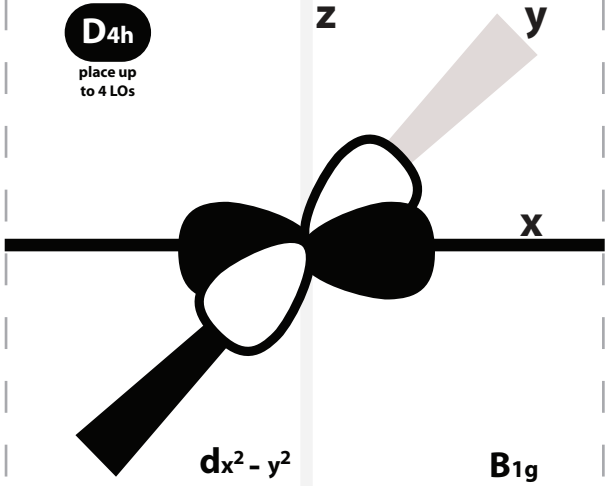

D_{4h}
place up
to 4 LOs

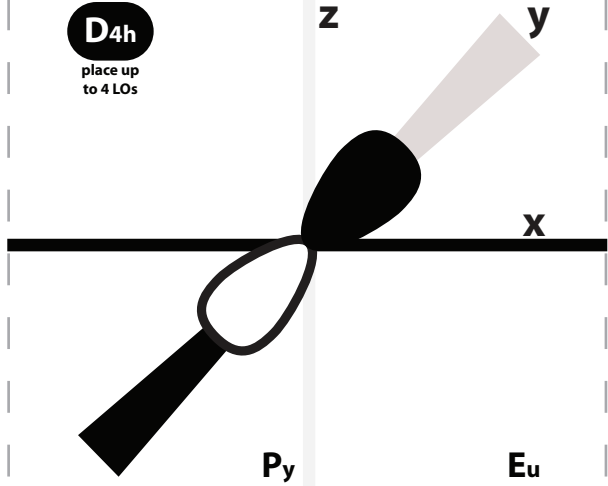

antibonding
D_{4h}
place up
to 4 LOs

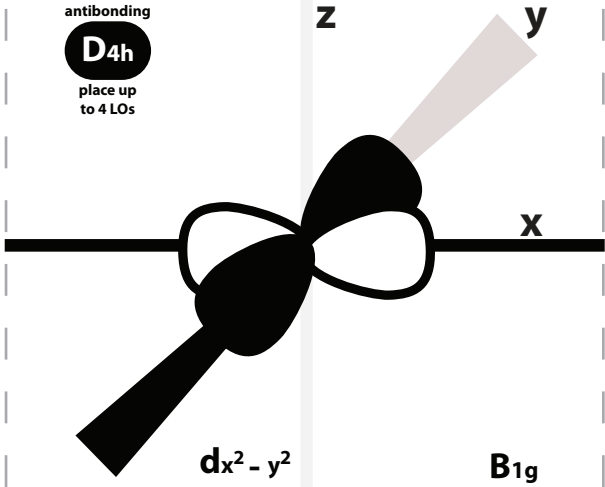

antibonding
D_{4h}
place up
to 4 LOs

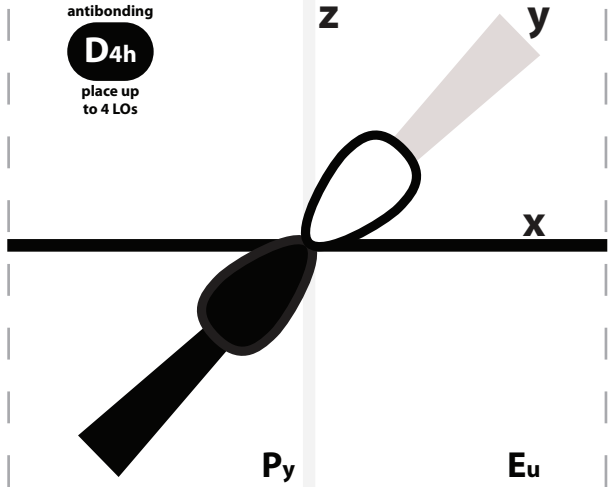

D_{4h}
place up
to 4 LOs



D_{4h}
place up
to 4 LOs

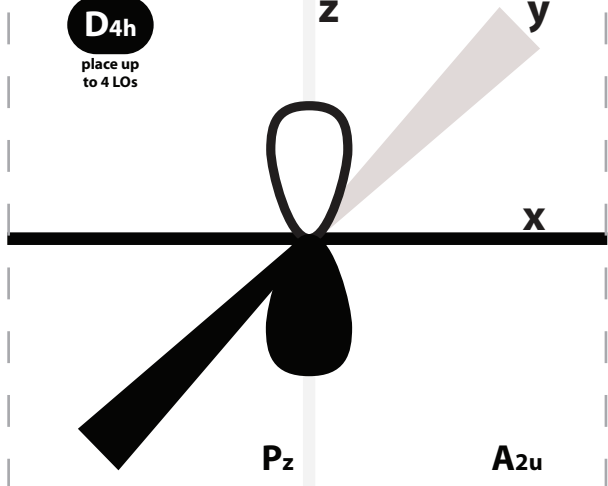

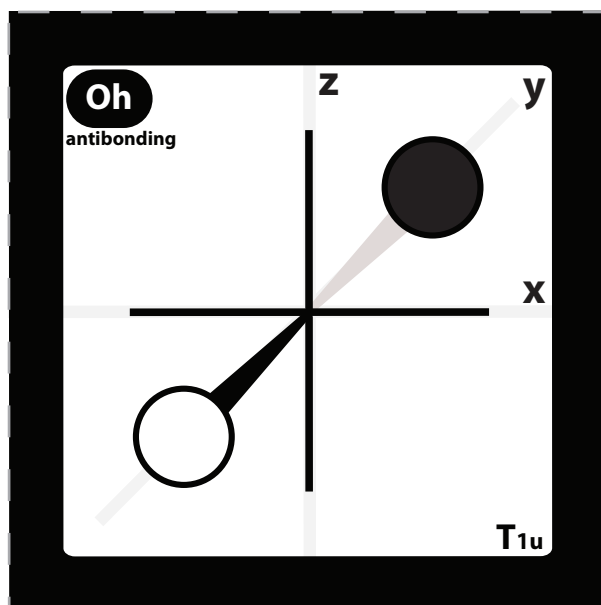
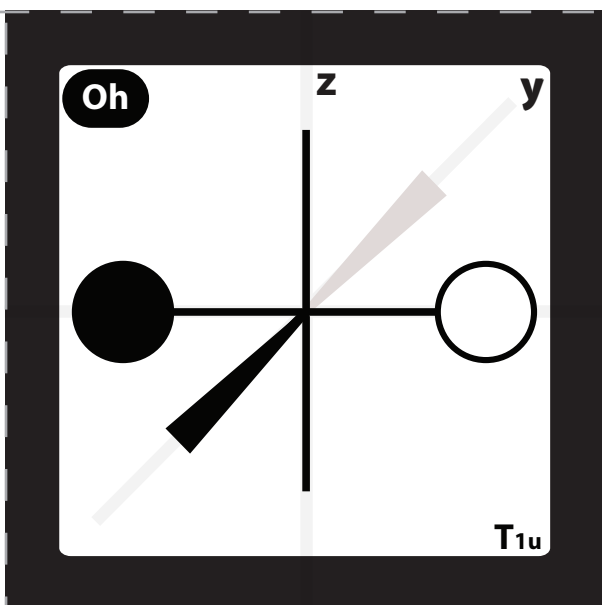
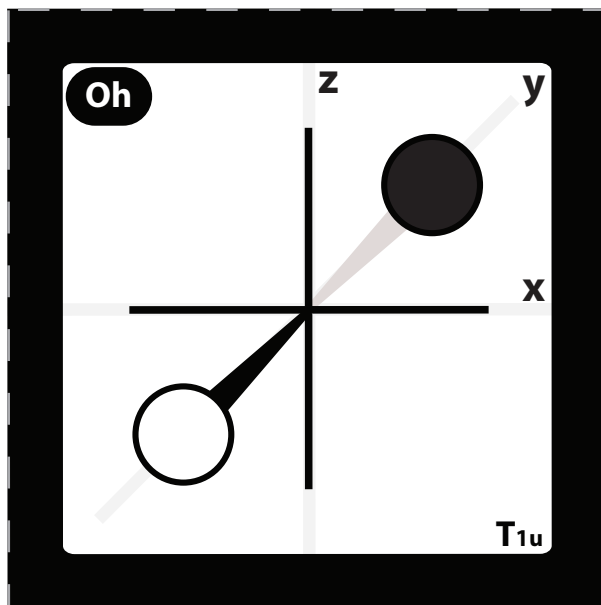
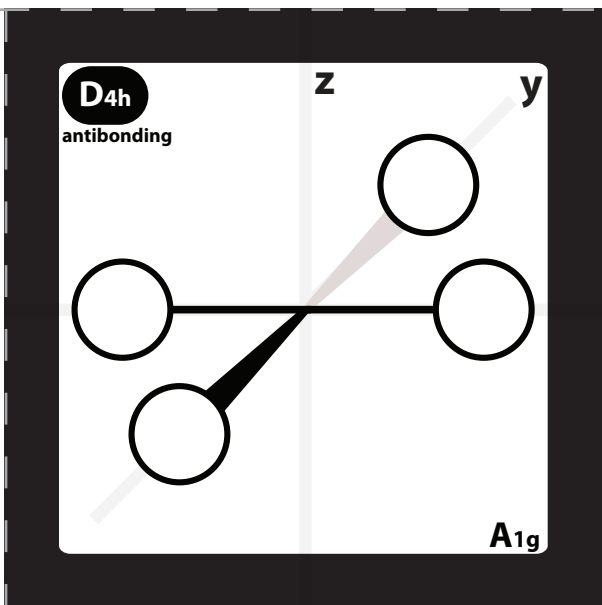
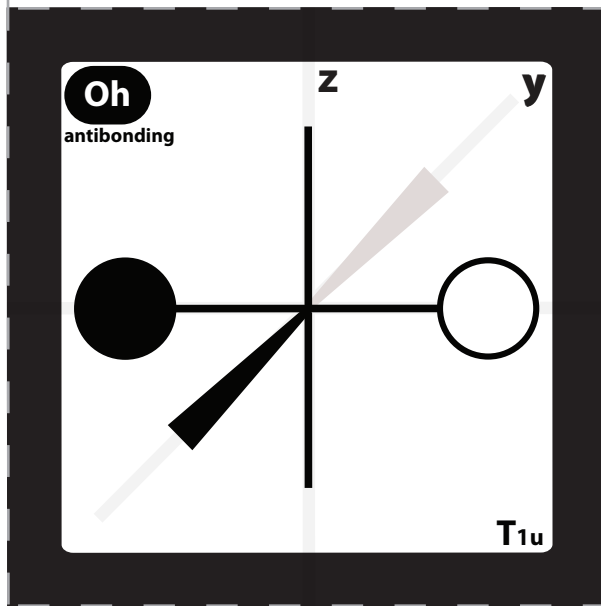
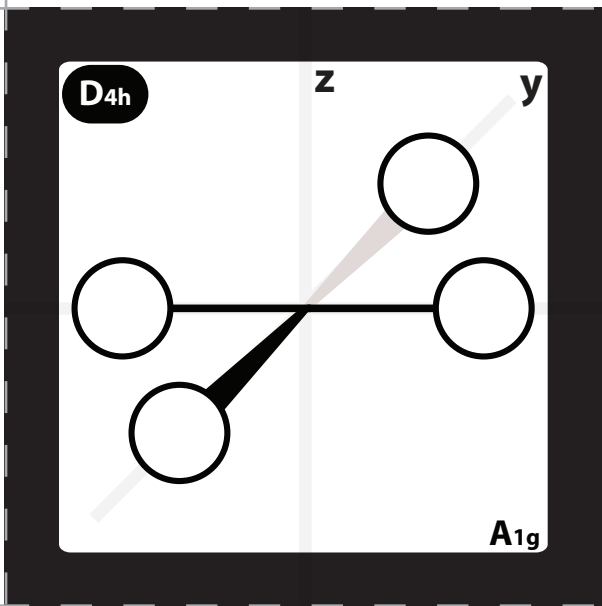

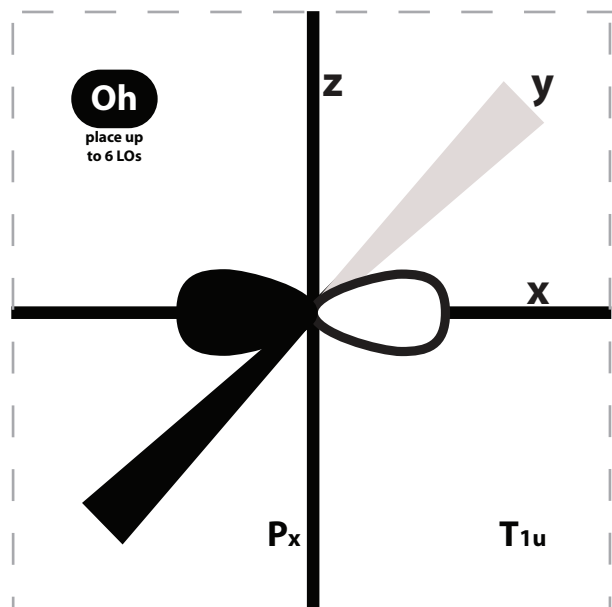
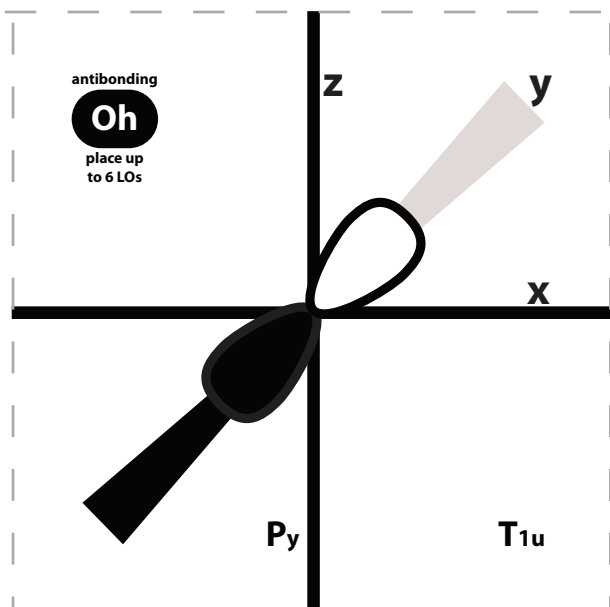
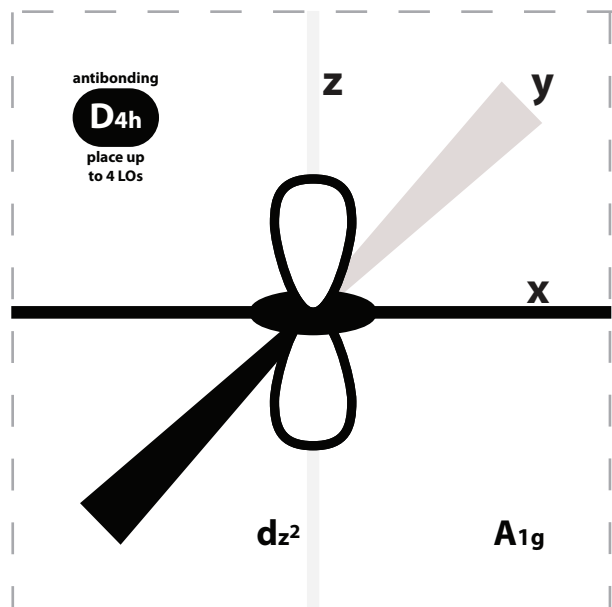
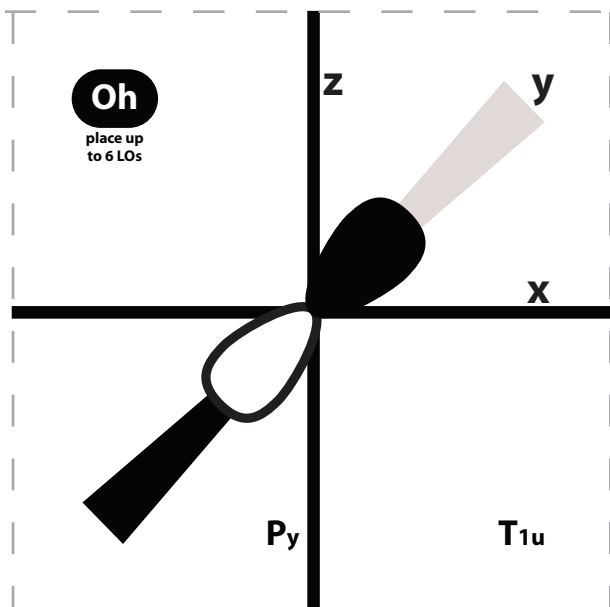
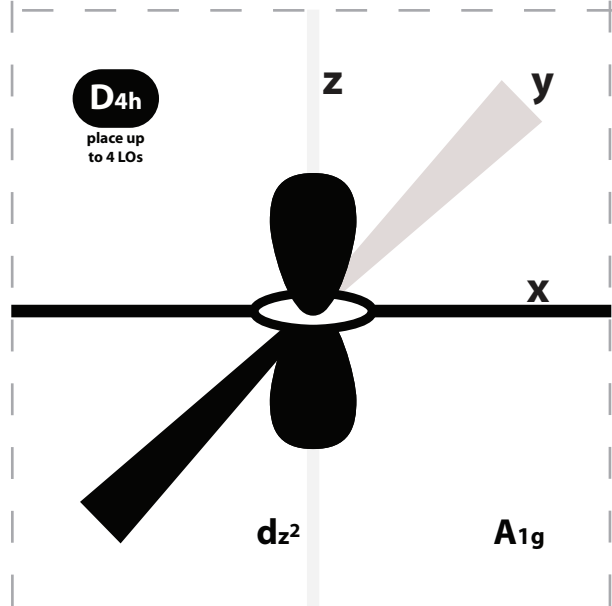
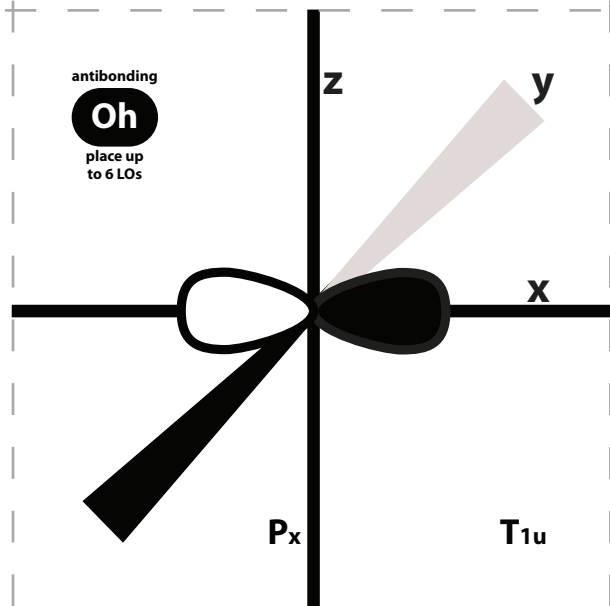

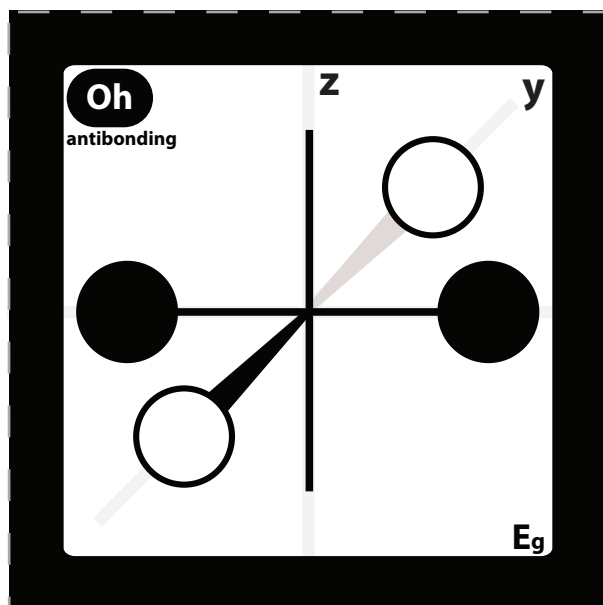
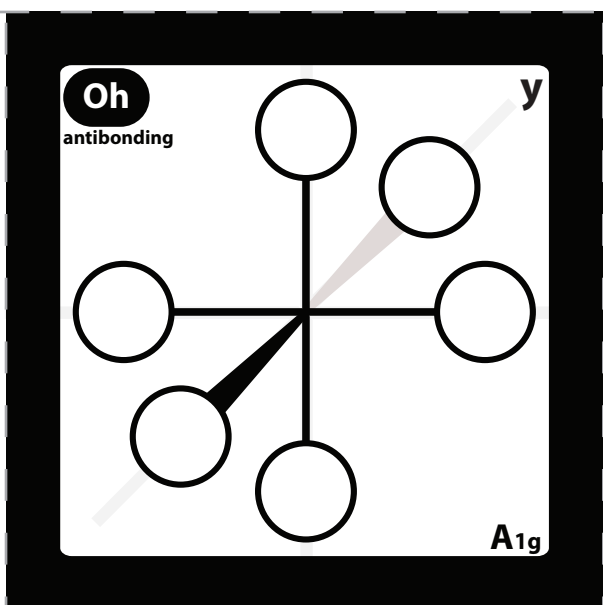
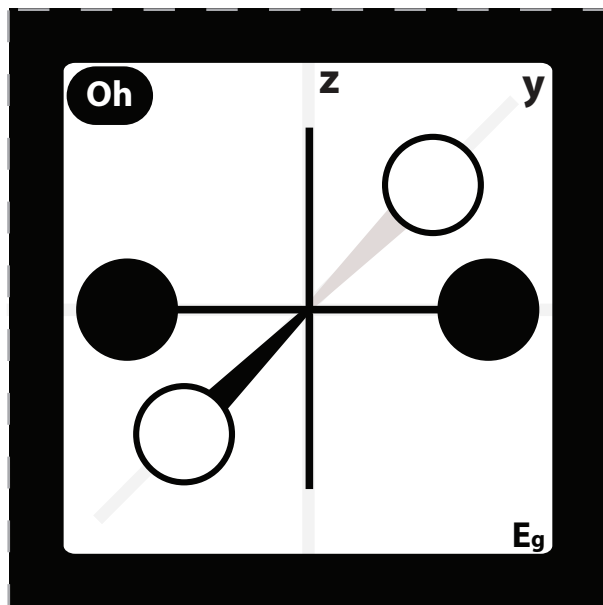
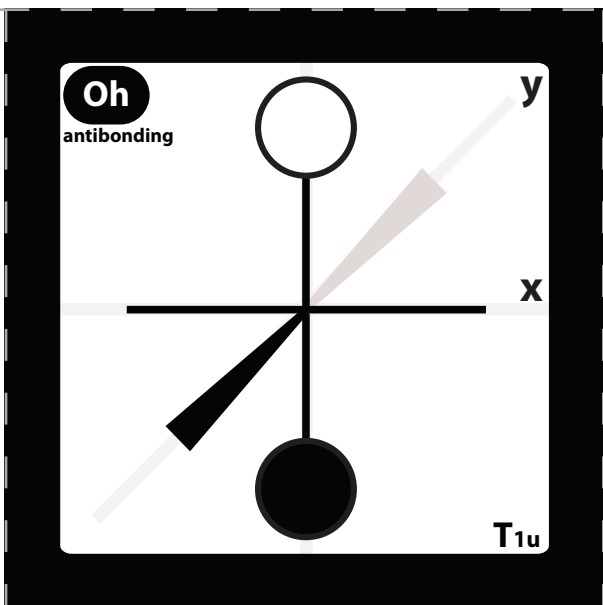
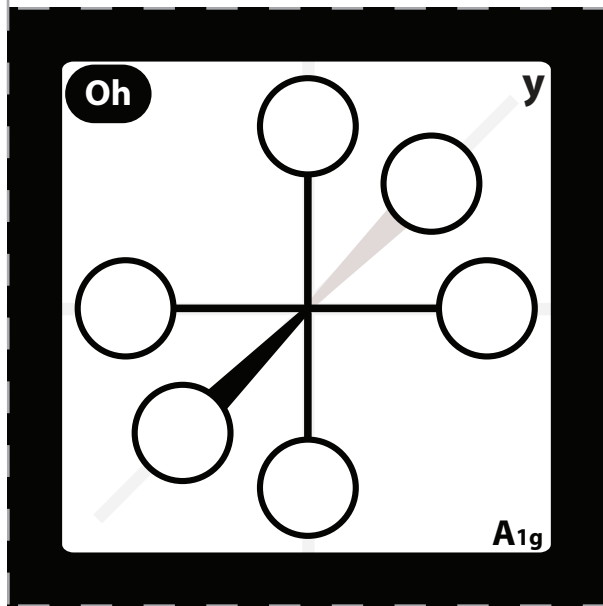
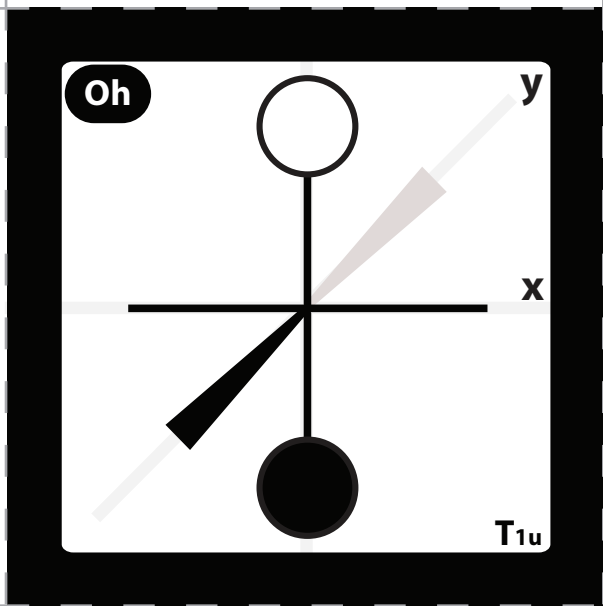

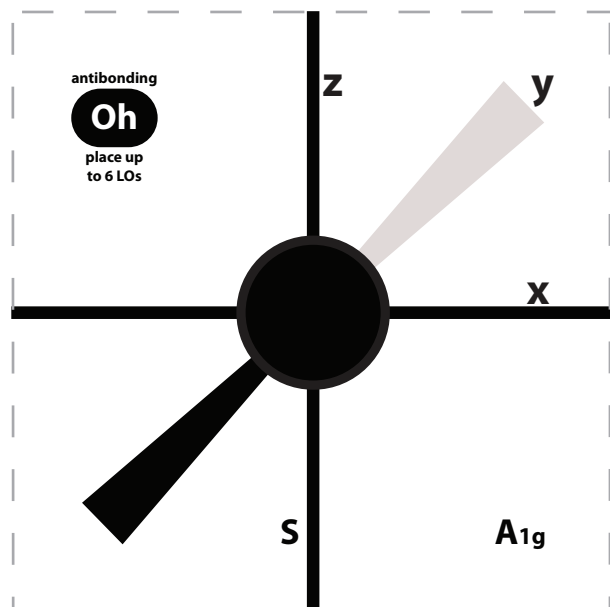
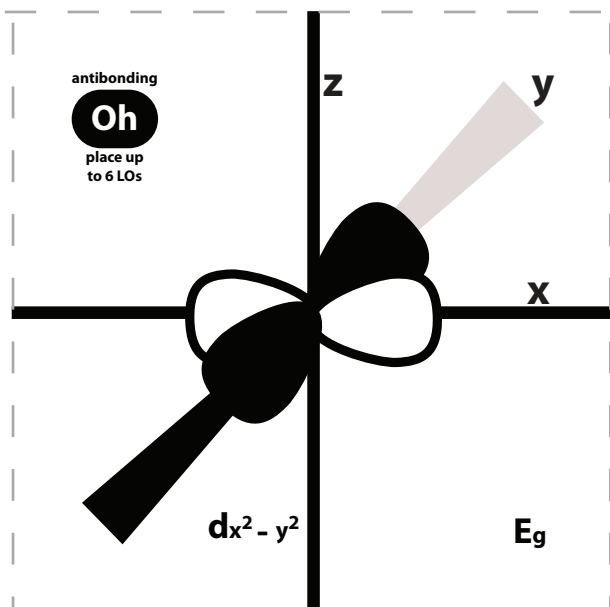
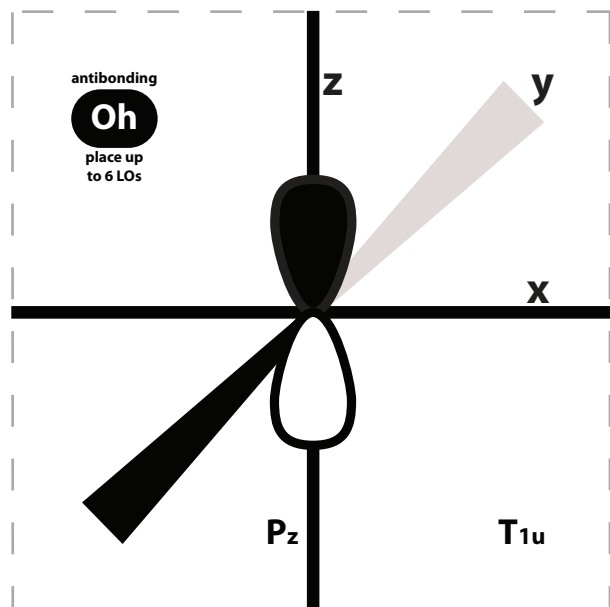
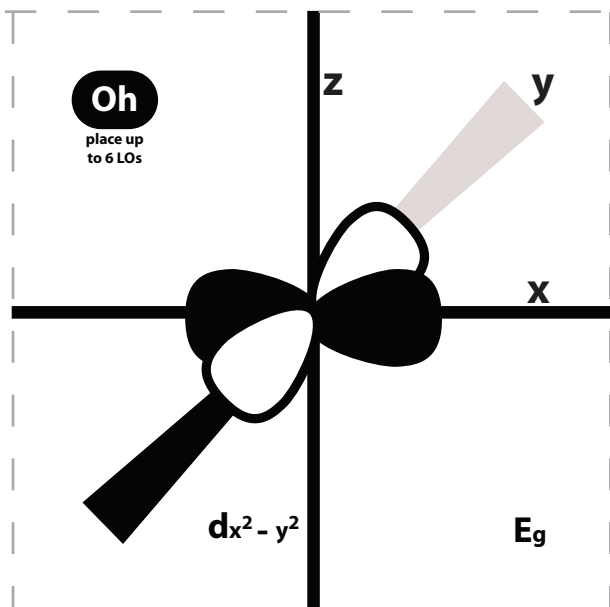
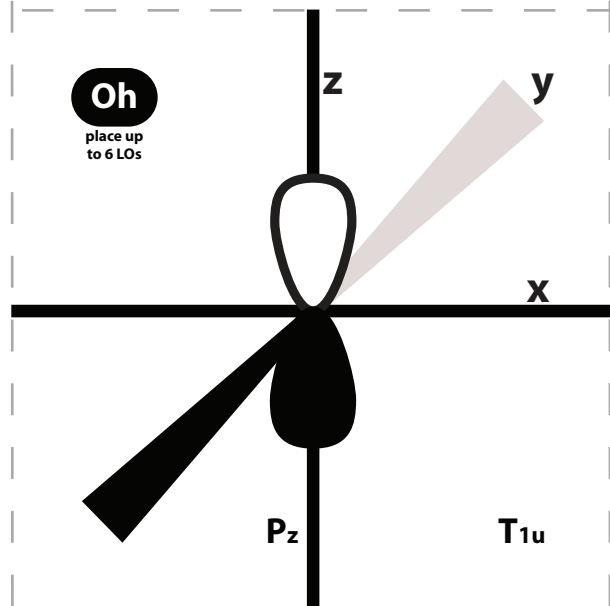
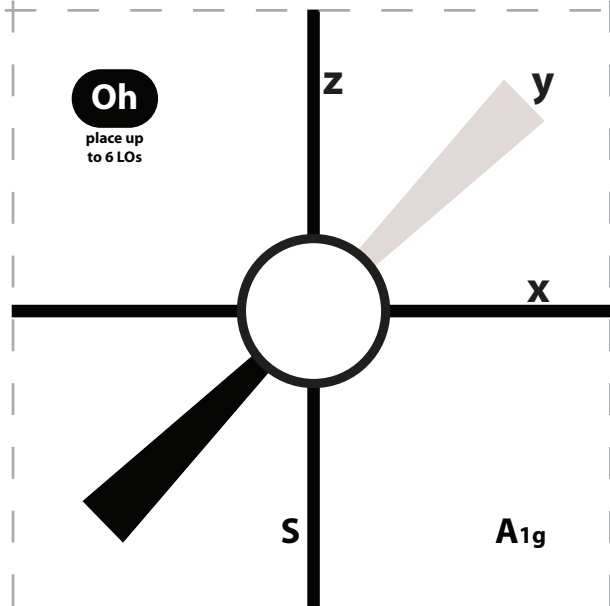

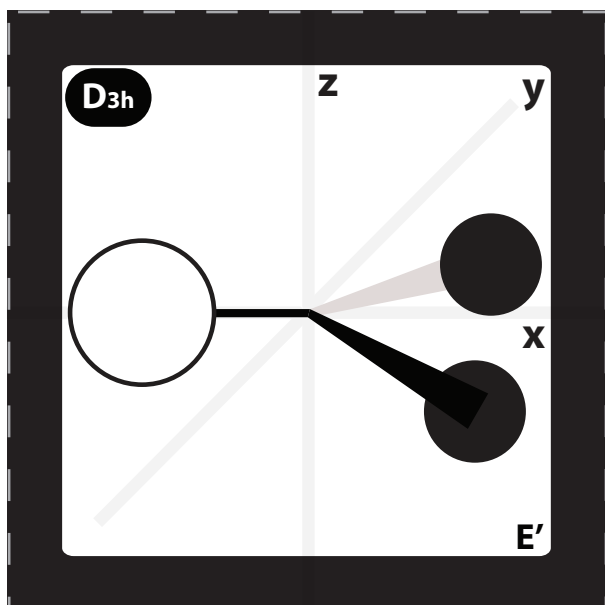
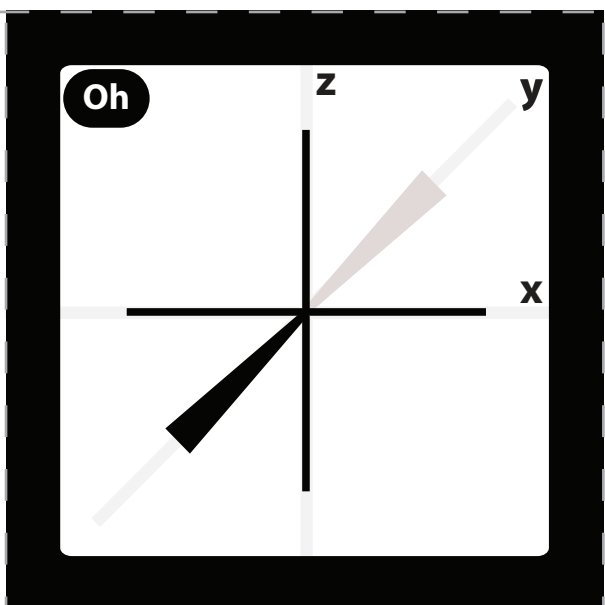
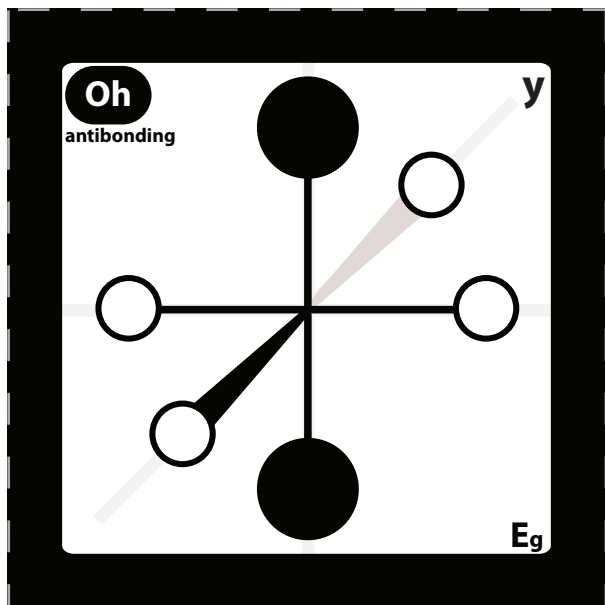
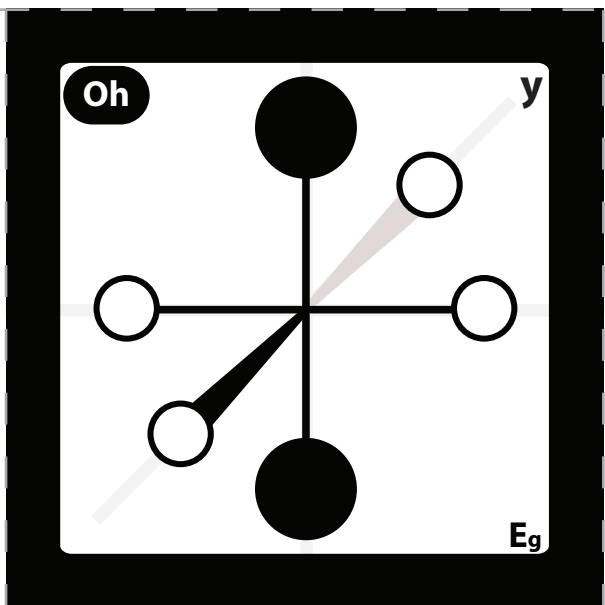
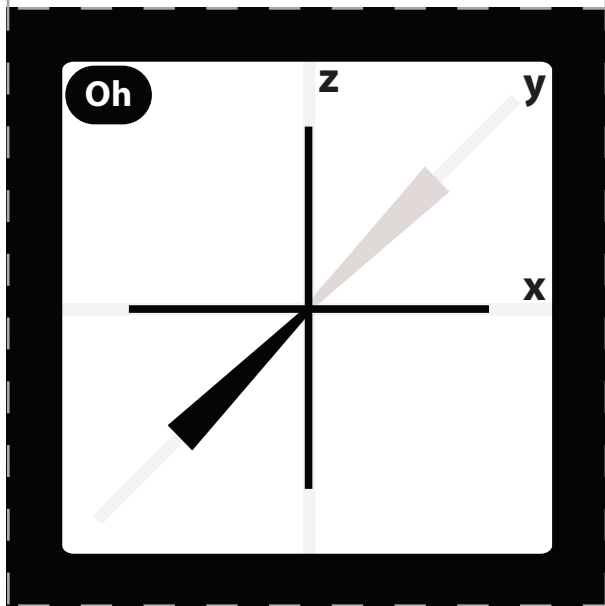
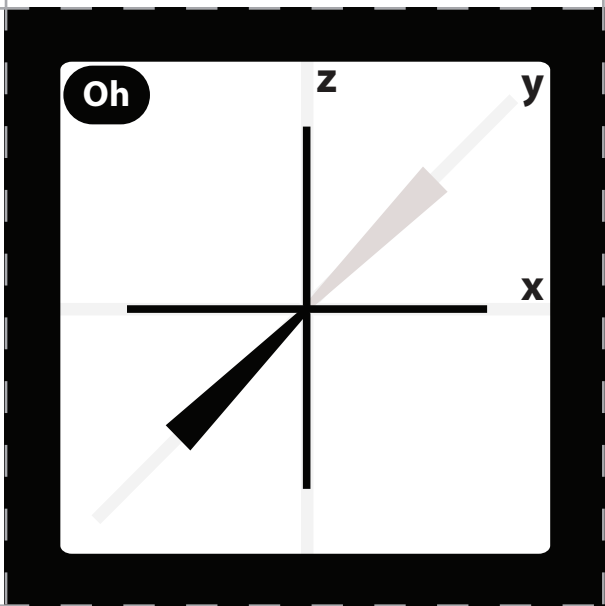

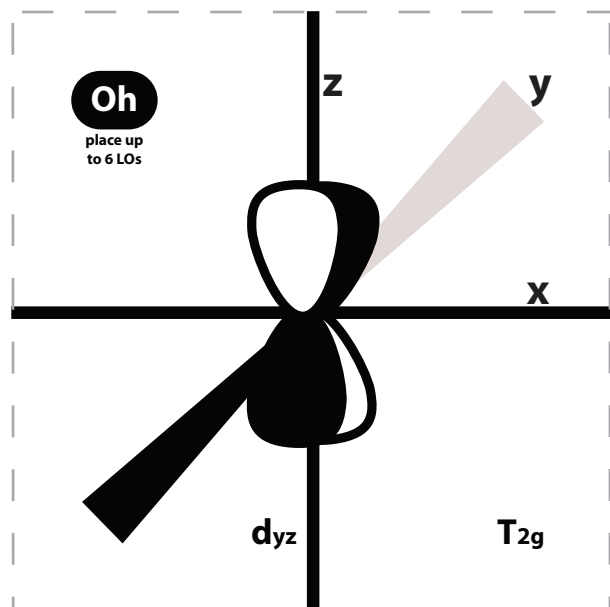
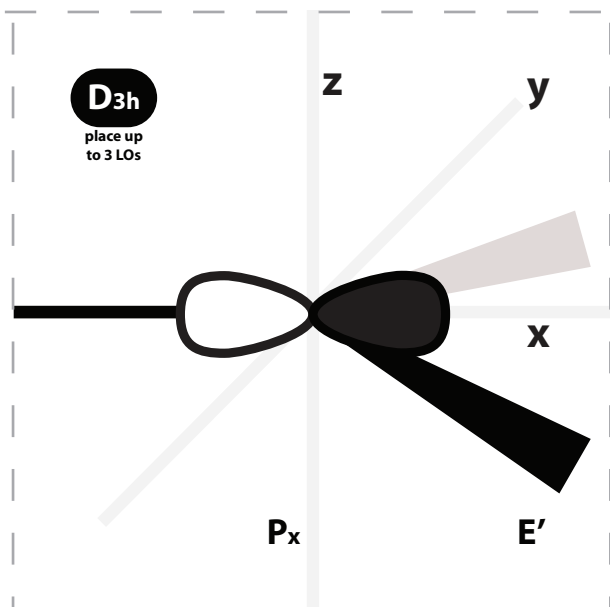
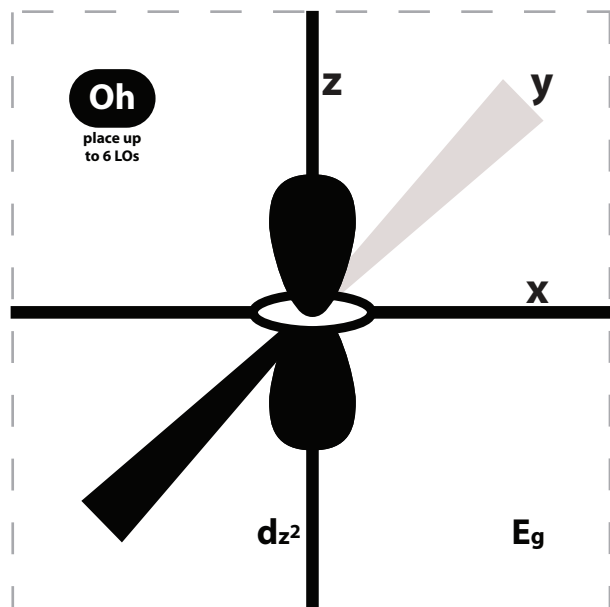
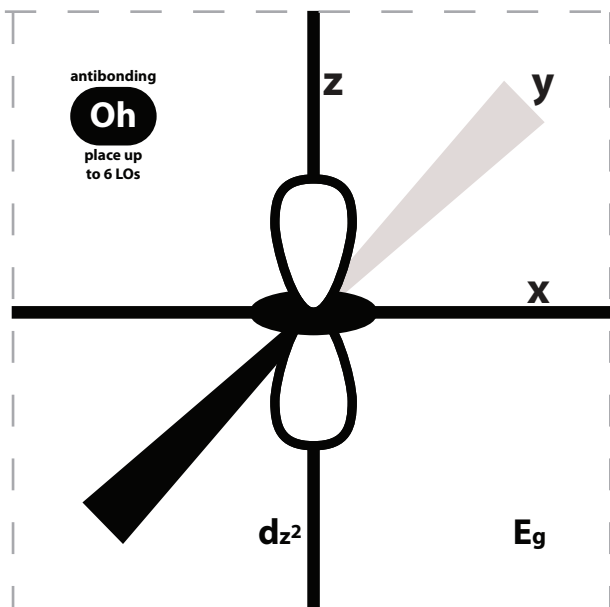
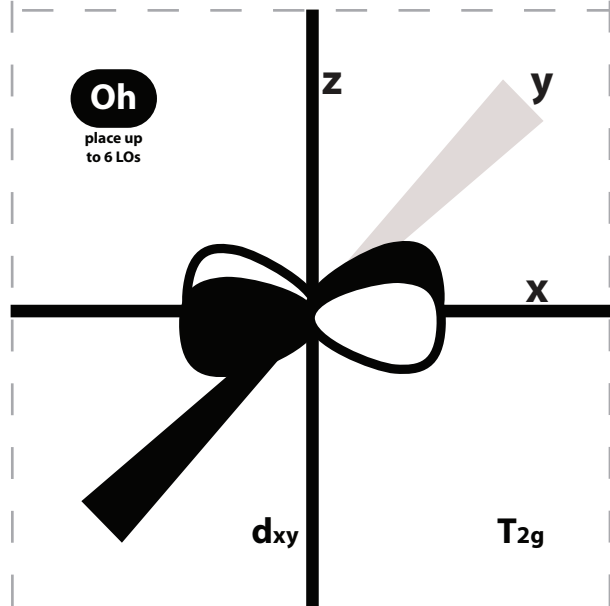
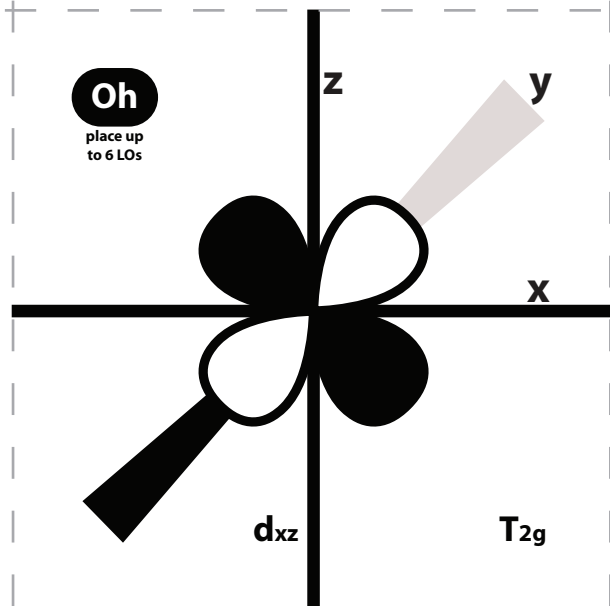

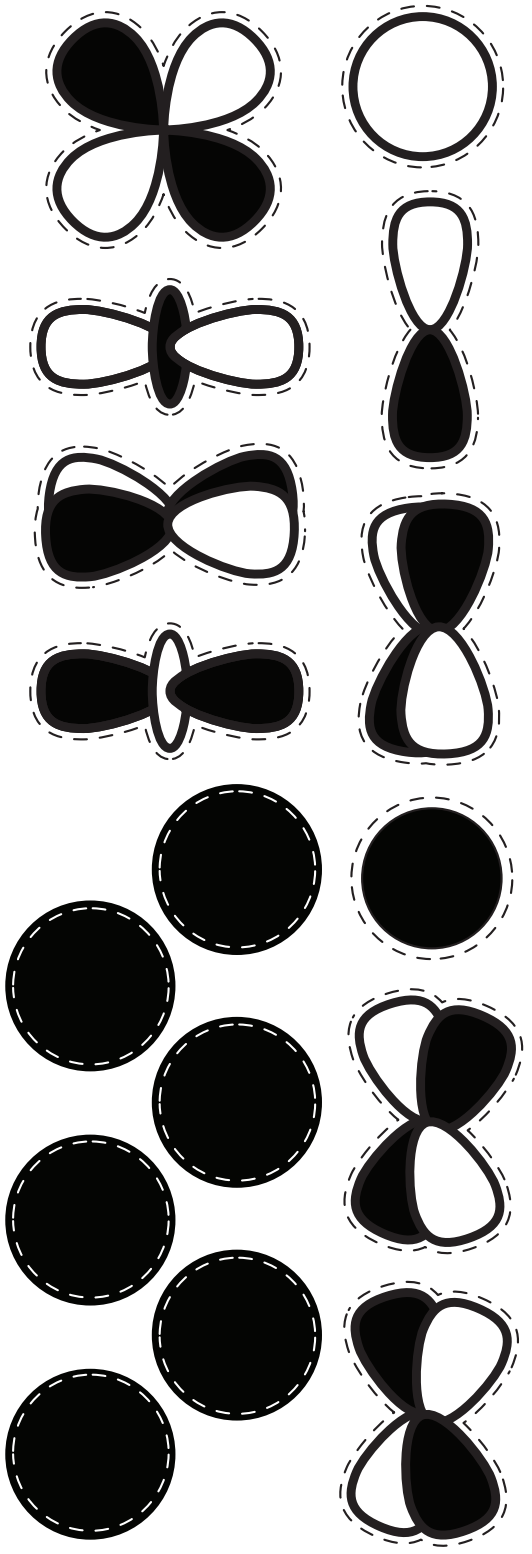

			1	2	1	2
	<i>s</i>					
		<i>d_{xz}</i>				
			3	4	3	4
	<i>P_x or P_y or P_z</i>					
		<i>z²p</i>				
			5	6	5	6
		<i>d_{yz} or d_{xy}</i>				
	<i>x²-y²</i>		1	2	1	2
		<i>z²p</i>				
			3	4	3	4
	<i>s</i>					
			5	6	5	6
	<i>z²-x²</i>		1	2	1	2
			3	4	3	4
	<i>z²-y²</i>		5	6	5	6

WINNING BETS



BETTING AREA



LOSING BETS



Examples of symmetry adapted linear combinations of ligand atomic orbitals

Molecule
(Point Group)

LACOs
(Multiken Symbol)

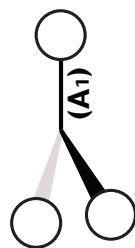

BH₃
(D_{3h})

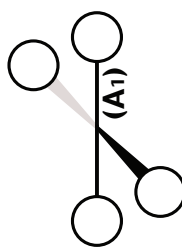

[AuCl₄]⁻
(D_{4h})

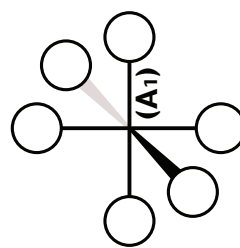

[PtCl₆]²⁻
(O_h)

BETTING AREA

YES

YES

YES

NO

NO

NO

Examples of symmetry adapted linear combinations of ligand atomic orbitals

Molecule
(Point Group)

LACOs
(Multiken Symbol)

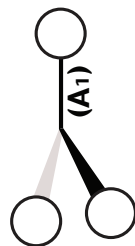

BH₃
(D_{3h})

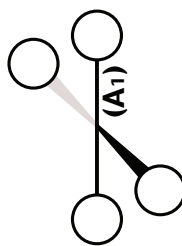

[AuCl₄]⁻
(D_{4h})

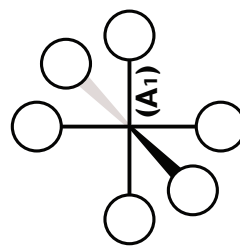

[PtCl₆]²⁻
(O_h)

Examples of symmetry adapted linear combinations of ligand atomic orbitals

Molecule
(Point Group)

LACOs
(Mulliken Symbol)

H₂O
(C_{2v})

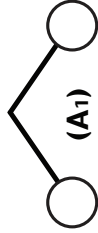

NH₃
(C_{3v})



[SeF₅]⁻
(C_{4v})

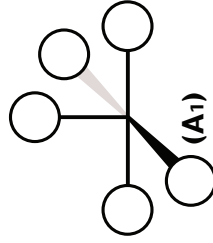

Examples of symmetry adapted linear combinations of ligand atomic orbitals

Molecule
(Point Group)

LACOs
(Mulliken Symbol)

H₂O
(C_{2v})



NH₃
(C_{3v})



[SeF₅]⁻
(C_{4v})

